

Rangaire

Product Installation & User Manual

Rangaire

Rangaire: 30" Gas Range | RRG303TS

PRODUCT INSTALLATION

RANGE SAFETY	1
Anti-Tip Device	3

INSTALLATION REQUIREMENTS	4
Tools and Parts	4
Location Requirements	5
Product Dimensions	6
Clearances	7
Venting Requirements	8
Electrical Requirements	9
Gas Supply Requirements	12

INSTALLATION INSTRUCTIONS	15
Unpack Range	15
Install Anti-tip Device	16
Install Backsplash	17
Gas Connection	18
Complete Connection	20
Adjust Flame Height	21
Level Range	22

GAS CONVERSION	24
Convert Gas Pressure Regulator	25
Convert Surface Burners	26
Convert Oven Bake Burner	28
Convert Oven Broil Burner	29
Complete Gas Conversion	29



Rangaire

Rangaire: 30" Gas Range | RRG303TS

PRODUCT USAGE & MAINTENANCE

RANGE SAFETY	31
Important Safety Instructions	31

OVERVIEW	35
Control Panel	37
Clock and Timer	37

COOKTOP USE	40
Power Failure	40
Cookware	41

OVEN USE	42
-----------------------	----

RANGE CARE	45
Cleaning	45



TROUBLESHOOTING	48
Baking Problems	48
Cooktop Problems	49
Oven Problems	50

CORRECT DISPOSAL	52
-------------------------------	----



YOUR SAFETY AND THE SAFETY OF OTHERS ARE VERY IMPORTANT.
 We have provided many important safety messages in this manual and on your appliance.
 Always read and obey all safety messages.

	<p>This is the safety alert symbol. This symbol alerts you to potential hazards that can kill or hurt you and others. All safety messages will follow the safety alert symbol and either the word "DANGER", "WARNING" or "CAUTION".</p>
---	---

 DANGER	<p>An imminently hazardous situation. You could be killed or seriously injured if you don't immediately follow instructions.</p>
 WARNING	<p>A potentially hazardous situation which, if not avoided, could result in death or serious bodily injury.</p>
 CAUTION	<p>A potentially hazardous situation which, if not avoided, may result in moderate or minor injury.</p>

All safety messages will tell you what the potential hazard is, tell you how to reduce the chance of injury, and tell you what can happen if the instructions are not followed.

In the State of Massachusetts, the following installation instructions apply:

- Installations and repairs must be performed by a qualified or licensed contractor, plumber, or gas fitter qualified or licensed by the State of Massachusetts.
- If using a ball valve, it shall be a T-handle type.
- A flexible gas connector, when used, must not exceed 3 feet.

California Proposition 65 Warnings:

WARNING: This product contains one or more chemicals known to the State of California to cause cancer.

WARNING: This product contains one or more chemicals known to the State of California to cause birth defects or other reproductive harm.

Cancer and Reproductive Harm - www.P65Warnings.ca.gov.

⚠️ WARNING



FIRE HAZARD

RANGE SAFETY

If the information in this manual is not followed exactly, a fire or explosion may result causing property damage, personal injury or death.

Do not store or use gasoline or other flammable vapors and liquids in the vicinity of this or any other appliance.

⚠️ WARNING

Never Operate the Top Surface Cooking Section of this Appliance Unattended

Failure to follow this warning statement could result in fire, explosion, or burn hazard that could cause property damage, personal injury, or death.

If a fire should occur, keep away from the appliance and immediately call your fire department.

DO NOT ATTEMPT TO EXTINGUISH AN OIL/GREASE FIRE WITH WATER.

WHAT TO DO IF YOU SMELL GAS:

- Do not try to light any appliance.
- Do not touch any electrical switch.
- Do not use any phone in your building.
- Clear the room, building, or area of all occupants.
- Immediately call your gas supplier from a neighbor's phone. Follow the gas supplier's instructions.
- If you cannot reach your gas supplier, call the fire department.
- Installation and service must be performed by a qualified installer, service agency or the gas supplier.

⚠️ WARNING



TIP-OVER HAZARD

- A child or adult can tip the range and be killed.
- Install anti-tip bracket to floor or wall per installation instructions.
- Slide range back so rear range foot is engaged in the slot of the anti-tip bracket.
- Re-engage the anti-tip bracket if range is moved.
- Do not operate the range without anti-tip bracket installed and engaged.
- Failure to follow these instructions can result in death or serious burns to children and adults

ANTI-TIP BRACKET

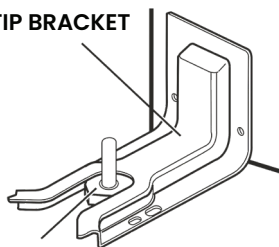

RANGE FOOT

Making sure the anti-tip bracket is installed:

- Slide range forward.
- Look for the anti-tip bracket securely attached to floor and wall.
- Slide range back so rear range foot is under anti-tip bracket.





⚠️ WARNING

Gas leaks cannot always be detected by smell.

Gas suppliers recommend that you use a gas detector approved by UL or CSA. For more information, contact your gas supplier.

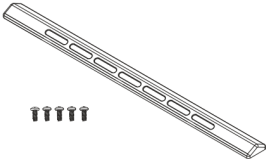
⚠️ WARNING

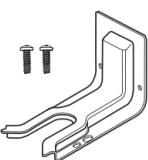
Do not install a ventilation system that blows air downward toward this cooking appliance. This type of ventilation system may cause ignition and combustion problems with this cooking appliance resulting in personal injury or unintended operation.

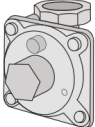
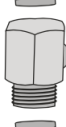
INSTALLATION REQUIREMENTS	
<p>Gather the required tools and parts before starting installation. Read and follow the instructions provided with any tools listed here.</p>	
Tools Needed:	
<ul style="list-style-type: none"> • Tape Measure • Flat-Blade Screwdriver • Phillips Screwdriver • Level • Drill • Wrench or Pliers • Pipe Wrench 	<ul style="list-style-type: none"> • 15/16" (2.4 cm) Combination Wrench • 1/8" (3.2 mm) Drill Bit (for wood floors) • Marker or Pencil • Pipe-Joint Compound Resistant to Propane Gas • 3/16" (4.8 mm) Carbide-Tipped Masonry Drill Bit (for concrete/ ceramic floors) • Non-Corrosive Leak-Detection Solution
For Propane/Natural Gas Conversions	
<ul style="list-style-type: none"> • 1/2" (1.3 cm) Combination Wrench • 1/4" (6 mm) Nut Drive 	<ul style="list-style-type: none"> • 9/32" (7 mm) Nut Drive • Maskingtape
Parts Supplied:	Parts Needed:
 <p>Backsplash + screws</p>	 <p>Gas supply line kit (supply line and 2 adapters)</p>
 <p>Anti-tip bracket + screws</p>	 <p>LP conversion kits</p>
 <p>Gas pressure regulator</p>	 <p>Gas pipe adapter + washers</p>

INSTALLATION REQUIREMENTS

IMPORTANT

Observe all governing codes and ordinances. Do not obstruct flow of combustion and ventilation air.



It is the installer's responsibility to comply with installation clearances specified on the model/serial rating plate. The model/serial rating plate is located behind the oven door on the oven frame.

- The range should be located for convenient use in the kitchen.
- Recessed installations must provide complete enclosure of the sides and rear of the range.
- To eliminate the risk of burns or fire by reaching over heated surface units, cabinet storage space located above the surface units should be avoided. If cabinet storage is to be provided, the risk can be reduced by installing a range hood or microwave hood combination that projects horizontally a minimum of 5" (12.7 cm) beyond the bottom of the cabinets.
- All openings in the wall or floor where range is to be installed must be sealed.
- Do not seal the range to the side cabinets.
- Cabinet opening dimensions that are shown must be used.
- Grounded electrical supply is required. See "Electrical Requirements" section.
- Proper gas supply connection must be available. See "Gas Supply Requirements" section.
- Contact a qualified floor covering installer to check that the floor covering can withstand at least 200°F (93°C).
- Use an insulated pad or 1/4" (0.64 cm) plywood under range if installing range over carpeting.

Mobile Home Installations Require:

- When this range is installed in a mobile home, it must be secured to the floor during transit. Any method of securing the range is adequate as long as it conforms to the standards listed above.
- Four-wire power supply cord or cable must be used in a mobile home installation. The appliance wiring will need to be revised. See "Electrical Connection" section.
- The installation of this range must conform to the Manufactured Home Construction and Safety Standard, Title 24 CFR, Part 3280 (formerly the Federal Standard for Mobile Home Construction and Safety, Title 24, HUD Part 280). When such standard is not applicable, use the Standard for Manufactured Home Installations, ANSI A225.1/NFPA 501A or with local codes.
- In Canada, the installation of this range must conform with the current standards CAN/CSA-A240-latest edition, or with local codes.

PRODUCT DIMENSIONS

This manual covers several models. Your model may appear different from the models depicted. Dimensions given are maximum dimensions across all models.

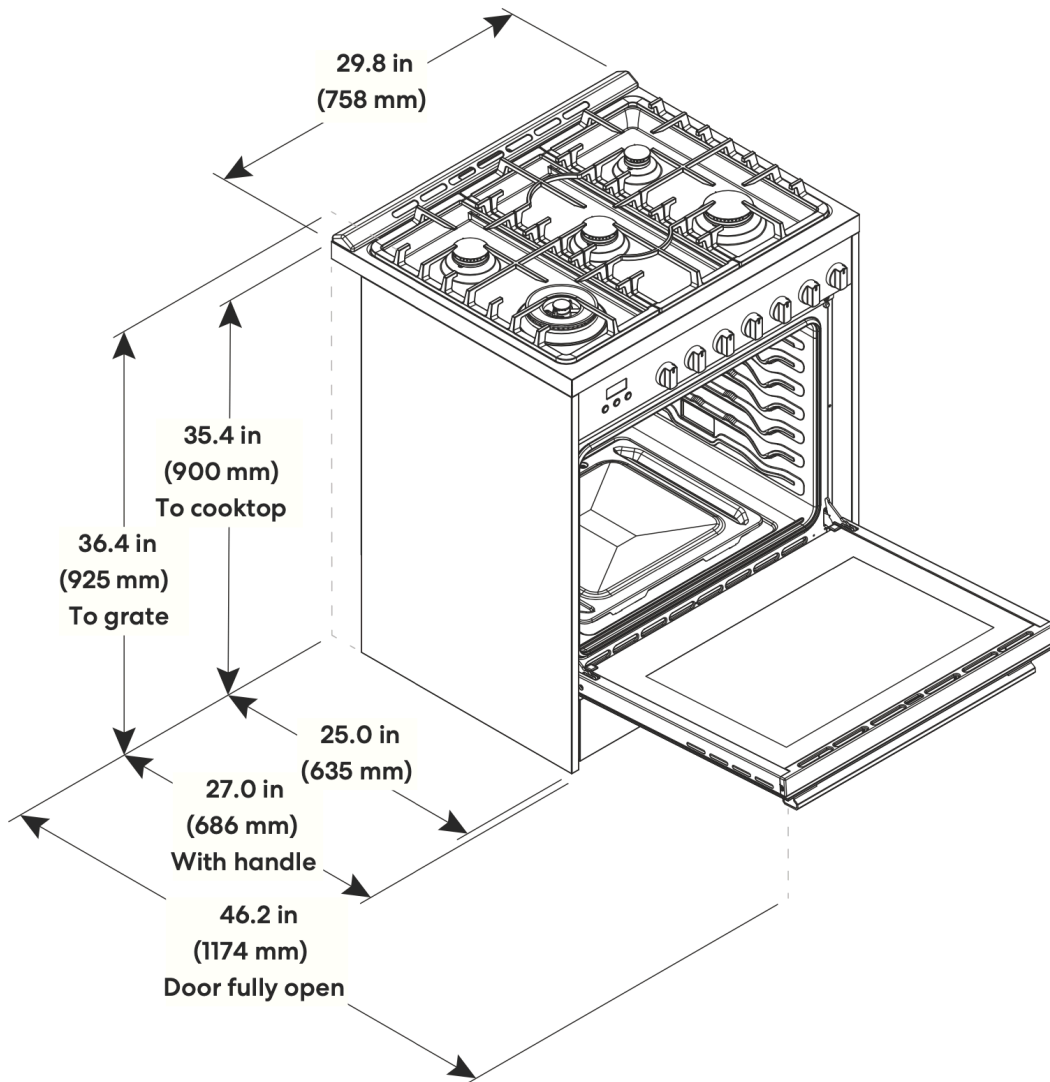

CLEARANCES

IMPORTANT

Some cabinet and building materials are not designed to withstand the heat produced by the oven for baking and self-cleaning. Check with your builder or cabinet supplier to make sure that the materials used will not discolor, delaminate or sustain other damage.

GIVEN DIMENSIONS ARE MINIMUM CLEARANCES.

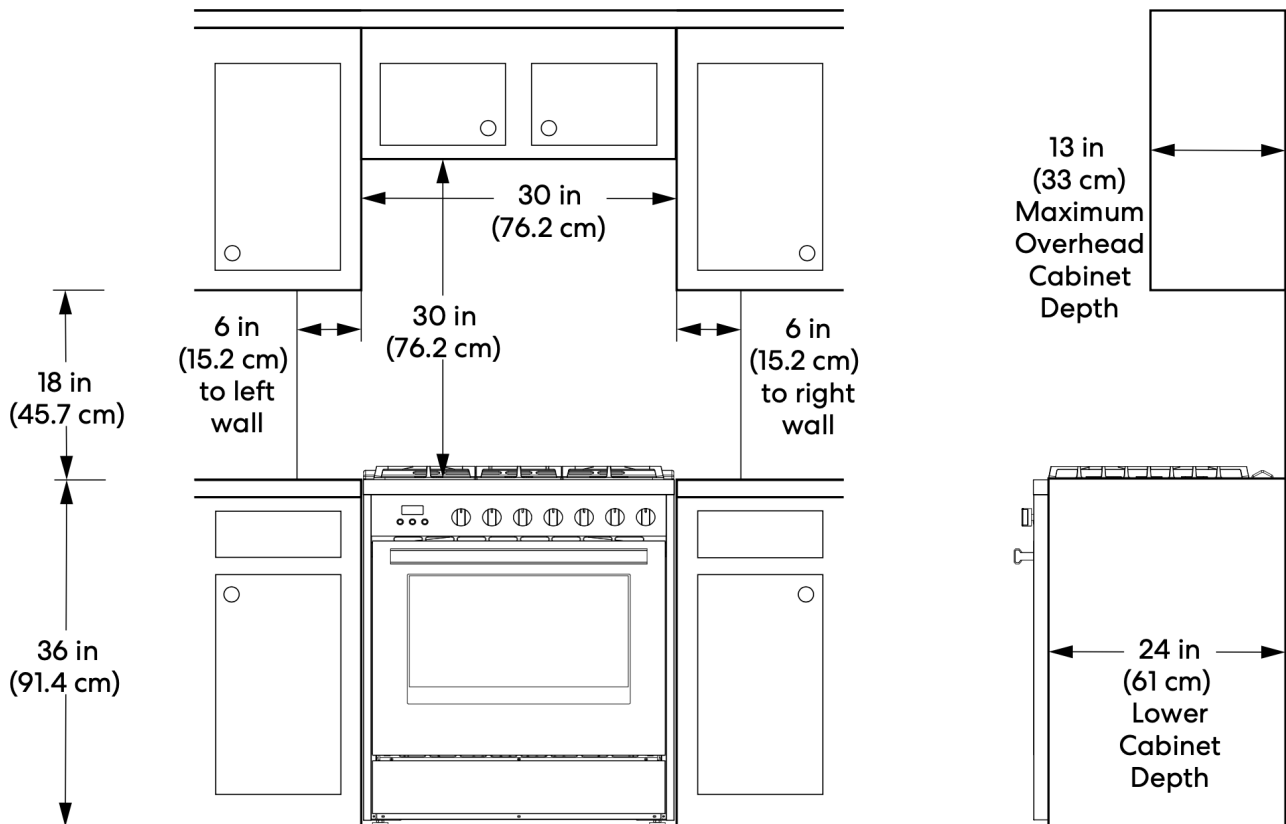

NOTE:

- 30" (76.2 cm) minimum clearance between cooking surface and bottom of the overhead cabinet.
- 18" (45.7 cm) minimum clearance from upper cabinet to countertop on either side of unit.

POWER SUPPLY LOCATION	
Ⓐ 30" (76 cm)	Ⓔ 3" (7.6 cm)
Ⓑ 24" (60.8 cm)	Ⓕ 30" (76 cm)
Ⓒ 6" (15.2 cm)	Ⓖ Recommended Location for Electrical Outlet
Ⓓ 7 1/4" (18.4 cm)	Ⓗ Recommended Location for Gas Supply Connection

IMPORTANT

An electrical outlet in the floor, may be either recessed or surface mounted, but an electrical outlet in the wall must be recessed to make the connection. For Direct Wiring, the electrical box should be mounted to the wall.

VENTING REQUIREMENTS

IMPORTANT

This range must be exhausted outdoors unless you are using ductless venting. Observe all governing codes and ordinances. Do not obstruct flow of combustion and ventilation air.

- Do not terminate the vent system in an attic or other enclosed area.
- Use an approved vent cap for proper performance. If an alternate wall or roof cap is used, be certain the cap size is not reduced and that it has a backdraft damper.
- Vent system must terminate to the outside unless you are using a ductless vent kit.
- Rigid metal vent is recommended. For best performance, do not use plastic or metal foil vent.
- If a joist or stud must be cut, then a supporting frame must be constructed.
- The size of the vent should be uniform.
- The vent system must have a damper.
- Seal all joints in the vent system.
- Use caulking to seal exterior wall or roof opening around the cap.
- Determine which venting method is best for your application.

MAKEUP AIR

Local building codes may require the use of makeup air systems when using ventilation systems greater than specified CFM of air movement. The specified CFM varies from locale to locale. Consult your HVAC professional for specific requirements in your area.

ELECTRICAL REQUIREMENTS

WARNING



**ELECTRICAL SHOCK
HAZARD**

Electrical Grounding Instructions

Electrically ground range.

Failure to do so can result in death, fire or electrical shock.

This appliance is equipped with a three-prong grounding plug for your protection against shock hazard and should be plugged directly into a properly grounded receptacle. Do not cut or remove the grounding prong from this plug.

This range is equipped with an electronic ignition system that will not operate if plugged into an outlet that is not properly polarized.

If codes permit and a separate ground wire is used, it is recommended that a qualified electrical installer determine that the ground path is adequate and wire gauge is in accordance with local codes.

Do not use an extension cord.

WARNING

Improper connection of the equipment-grounding conductor can result in a risk of electric shock. Check with a qualified electrician or service technician if you are in doubt as to whether the appliance is properly grounded. Do not modify the power supply cord plug. If it will not fit the outlet, have a proper outlet installed by a qualified electrician.

ELECTRICAL REQUIREMENTS - U.S.A. ONLY

Be sure that the electrical connection and wire size are adequate and in conformance with the National Electrical Code, ANSI/ NFPA No. 70-latest edition and all local codes and ordinances.

A copy of the above code standards can be obtained from:

National Fire Protection Association
1 Batterymarch Park
Quincy, MA 02169

ELECTRICAL REQUIREMENTS - CANADA ONLY

Be sure that the electrical connection and wire size are adequate and in conformance with the CSA Standard C22.1, Canadian Electrical Code, Part 1 - latest edition and all local codes and ordinances.

A copy of the above code standards can be obtained from:

Canadian Standards Association
178 Rexdale Blvd.
Toronto, ON M9W 1R3 CANADA

NOTICE:

The metal chassis of the range must be grounded in order for the control panel to work. If the metal chassis of the range is not grounded, no keypads will operate. Check with a qualified electrician if you are in doubt as to whether the metal chassis of the range is grounded.

ELECTRICAL CONNECTION

- The receptacle of this range is to be connected to a properly grounded dedicated circuit providing 120 VAC/60 Hz power and protected by a 15- or 20-Amp circuit breaker or slow blow fuse. It is recommended that a separate circuit serving only this range be provided.

- Where a standard two-prong wall receptacle is encountered, contact a qualified electrician to have it replaced with a properly grounded three-prong wall receptacle.

- This range is equipped with an electronic ignition system that will not operate if plugged into an outlet that is not properly polarized.

- Do not use an extension cord or an adapter plug.

- Check local codes and consult gas supplier. Check existing electrical supply and gas supply. It is recommended that all electrical connections be made by a licensed, qualified electrical installer.

- Range must be connected to the proper electrical voltage and frequency as specified on the model/serial rating plate. The plate is located behind the oven door on the oven frame. Refer to the illustrations in the "Location Requirements" section.

- A 120 volt, 60 Hz, AC only, 15-amp fused, electrical circuit is required. A time-delay fuse or circuit breaker is also recommended. It is recommended that a separate circuit serving only this range be provided.

- Electronic ignition systems operate within wide voltage limits, but proper grounding and polarity are necessary. Check that the outlet provides 120- volt power and is correctly grounded.

- This gas range is not required to be plugged into a GFCI (Ground-Fault Circuit Interrupter) outlet. It is recommended that you not plug an electric spark ignition gas range or any other major appliance into a GFCI wall outlet as it may cause the GFCI to trip during normal cycling.



- Performance of this range will not be affected if operated on a GFCI- protected circuit. However, occasional nuisance tripping of the GFCI breaker is possible due to the normal operating nature of electronic gas ranges.

- The wiring diagram is located on the back of the range in a clear plastic bag.

NOTICE:

The metal chassis of the range must be grounded in order for the control panel to work. If the metal chassis of the range is not grounded, no keypads will operate. Check with a qualified electrician if you are in doubt as to whether the metal chassis of the range is grounded.

GAS SUPPLY REQUIREMENTS

 WARNING	<p>Use a new CSA International approved gas supply line.</p> <p>Install a shut-off valve.</p> <p>Securely tighten all gas connections.</p>
 <p>FIRE AND EXPLOSION HAZARD</p>	<p>If connected to LP, have a qualified person make sure gas pressure does not exceed the maximum pressure listed in this section.</p> <p>Examples of a qualified person include:</p> <ul style="list-style-type: none"> • Licensed heating personnel • Authorized gas company personnel • Authorized service personnel <p>Failure to do so can result in death, explosion or fire.</p>

NOTICE:

Observe all governing codes and ordinances.

IMPORTANT: This installation must conform with all local codes and ordinances. In the absence of local codes, installation must conform with American National Standard, National Fuel Gas Code ANSI Z223.1/ NFPA 54 - latest edition or VCAN/CGA B149 - latest edition, or in Canada, the Natural Gas and Propane Installation Code, CSA B149.1 - latest edition.

IMPORTANT: Leak testing of the range must be conducted according to the manufacturer's instructions.

TYPE OF GAS

Natural Gas:

This range is design-certified by CSA International for use with natural gas or, after proper conversion, for use with LP gas.

- This range is factory-set for use with Natural gas. The model/serial/rating plate located behind the oven door on the oven frame has information on the types of gas that can be used. If the types of gas listed do not include the type of gas available, check with the local gas supplier.

LP Gas Conversion:

Conversion must be performed by a qualified service technician. The qualified agency performing this work assumes the gas conversion responsibility. No attempt shall be made to convert the appliance from the gas specified on the model/serial/rating plate for use with a different gas without consulting the serving gas supplier. See "Gas Conversion" section.

GAS SUPPLY REQUIREMENTS

GAS SUPPLY LINE

Provide a gas supply line of 3/4" (1.9 cm) rigid pipe to the range location. A smaller size pipe on longer runs may result in insufficient gas supply. Pipe-joint compounds that resist the action of LP gas must be used. With LP gas, piping or tubing size can be 1/2" (1.3 cm) minimum. Usually, LP gas suppliers determine the size and materials used in the system.

Flexible metal appliance connector:

• If local codes permit, a new CSA design-certified, 4 - 5 ft (122 - 152.4 cm) long, 1/2" (1.3 cm) or 3/4" (1.9 cm) I.D., flexible metal appliance connector may be used for connecting range to the gas supply line. In Canada, flexible connectors must be single wall metal connectors less than 6 feet (182.9 cm) in length.



• A 1/2" (1.3 cm) male pipe thread is needed for connection to the female pipe threads of the inlet to the appliance pressure regulator.

• Do not kink or damage the flexible metal tubing when moving the range.

Rigid pipe connection:

Since the range must be pulled away from the installation space to provide access to the gas regulator connections, and because hard piping restricts movement of the range, the range can only be installed using a CSA International-certified flexible metal appliance connector. If local codes require a hard-piped connection, a combination of pipe fittings must be used to connect the range to the existing gas line and maintain an accessible working space behind the range. Consult with a qualified local technician for an optimal connection suitable for your installation.

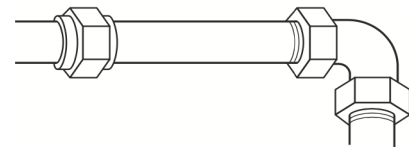

Gas shutoff valve:

A manual gas line shut-off valve must be installed in an easily accessible location. Do not block access to shut-off valve. The valve is for turning on or shutting off gas to the range.

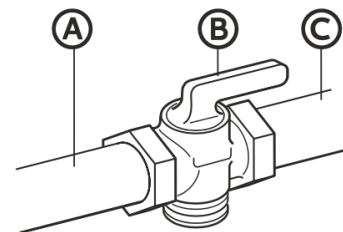

(A) Gas Supply Line (B) Shutoff Valve "Open" Position (C) To Range

GAS SUPPLY REQUIREMENTS

GAS PRESSURE REGULATOR

The gas pressure regulator supplied with this range must be used. The inlet pressure to the regulator should be as follows for proper operation:

	Natural Gas	LP Gas
Minimum Pressure	4" WCP	10" WCP
Maximum Pressure	7" WCP	11" WCP

Contact local gas supplier if you are not sure about the inlet pressure.

Burner Input Requirements

Input ratings shown on the model/serial rating plate are for elevations up to 2,000 ft (609.6 m).

For elevations above 2,000 ft (609.6 m), ratings are reduced at a rate of 4% for each 1,000 ft (304.8 m) above sea level (not applicable for Canada).

GAS SUPPLY PRESSURE TESTING

Gas supply pressure for testing regulator must be at least 1" (2.5 cm) water column pressure above the manifold pressure shown on the model/serial/rating plate.

Line pressure testing above 0.5 psi gauge (14" WCP)

The range and its individual shutoff valve must be disconnected from the gas supply piping system during any pressure testing of that system at test pressures in excess of 0.5 psi (3.5 kPa).

Line pressure testing at 0.5 psi gauge (14" WCP) or lower

The range must be isolated from the gas supply piping system by closing its individual manual shutoff valve during any pressure testing of the gas supply piping system at test pressures equal to or less than 1/2 psi (3.5 kPa).

INSTALLATION INSTRUCTIONS

IMPORTANT

This appliance shall be installed only by authorized persons and in accordance with the manufacturer's installation instructions, local gas fitting regulations, municipal building codes, electrical wiring regulations, local water supply regulations.

⚠ WARNING

EXCESSIVE WEIGHT HAZARD

Use two or more people to move and install range. Failure to do so can result in back or other injury.

UNPACK RANGE:

1. Remove shipping materials, tape and film from the range. Keep cardboard bottom under range. Do not dispose of anything until the installation is complete.
2. Remove oven racks and parts package from oven and shipping materials.
3. To remove cardboard bottom, first take 4 cardboard corners from the carton. Stack one cardboard corner on top of another. Repeat with the other 2 corners. Place them lengthwise on the floor behind the range to support the range when it is laid on its back.
4. Using two or more people, firmly grasp the range and gently lay it on its back on the cardboard corners.
5. Remove cardboard bottom.

NOTE:

- The leveling legs can be adjusted while the range is on its back.
- To place range back up into a standing position, put a sheet of cardboard or hardboard on the floor in front of range to protect the flooring. Using two or more people, stand range back up onto the cardboard or hardboard.

INSTALL ANTI-TIP DEVICE

⚠️ WARNING



TIP-OVER HAZARD

- A child or adult can tip the range and be killed.
- Install anti-tip bracket to floor or wall per installation instructions.
- Slide range back so rear range foot is engaged in the slot of the anti-tip bracket.
- Re-engage the anti-tip bracket if range is moved.
- Do not operate the range without anti-tip bracket installed and engaged.
- Failure to follow these instructions can result in death or serious burns to children and adults

IMPORTANT

- An anti-tip bracket is provided with the range. The anti-tip bracket uses a rear range foot to secure the range to the floor or wall.
- Attach the anti-tip bracket to the floor or wall so that the rear range foot will be centered within the bracket when the range is pushed into its final position.

- 1** Remove the anti-tip bracket and screws from the parts bag.

NOTE: The anti-tip bracket must be securely mounted to the subfloor or wall. The flooring's thickness may require longer screws to anchor bracket to subfloor.

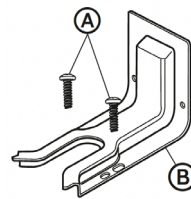

- A** 16 x 1⁵/₈" Screws (2)
- B** Anti-tip Bracket

- 2** Place the bracket so that the back of the bracket is against the rear wall and the side edge of the bracket is 3/8" to 1/2" from the adjacent cabinet.

NOTE: If there is no adjacent cabinet, place the bracket so that the edge of the bracket is 3/8" to 1/2" in from the range side panel. If the countertop overhangs the cabinet, offset the bracket from the cabinet by the depth of the overhang plus an additional 3/8" to 1/2".

- 3** Using the anti-tip bracket as a template, mark the two holes for either a Floor Wood, Floor Concrete, or Wall installation, as shown.

- A** Distance from Adjacent Cabinet (3/8" to 1/2" [0.95 cm to 1.27 cm])
- B** Wall Holes **C** Concrete Floor Holes **D** Wood Floor Holes
- E** Rear Range Foot

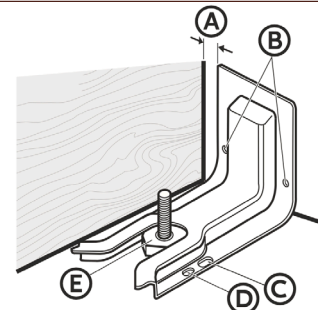

4 Drill two pilot holes where marked. Follow the instructions specific to your construction.

NOTE: A nail or awl may be used to create a pilot hole, if a drill is not available. For concrete construction 1/4" x 1 1/2" Lag Bolts and 1/2" O.D. Sleeve Anchors are required.

Wood

Floor: Drill a 1/8" pilot hole, as shown.

NOTE: Contact a qualified floor covering installer for the best procedure for drilling mounting holes through your type of floor covering.

Wall: Drill a 1/8" pilot hole, as shown.

Concrete

Drill the size hole recommended for the anchors into the concrete at the center of the holes identified as Floor Concrete or Wall.

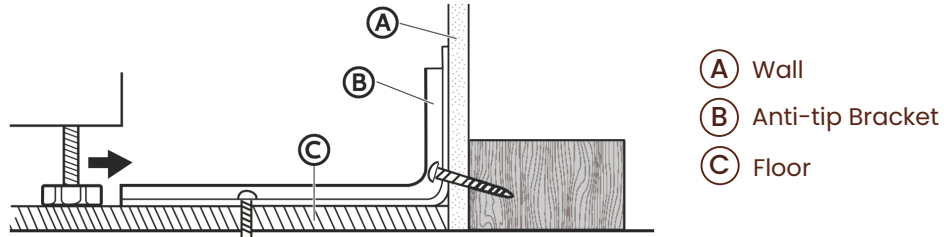

5 Install the anti-tip bracket.

Wood

Using the two screws (provided) fasten the anti-tip bracket to the floor or wall.
NOTE: The screw must enter wood or metal.

Concrete

Insert the sleeve anchor into the drilled holes and then insert the lag bolts through the anti-tip bracket and into the floor or wall. The bolts must be properly tightened as recommended for the hardware.

INSTALL BACKSPLASH

Install the backsplash to rear of range with the screws provided.

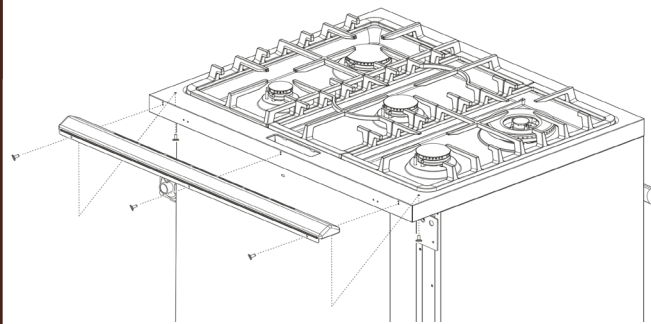

6 Install oven door handle (for units without the handle pre-installed)

Be very careful not to scratch the surface of the unit. The appearance of the handle may vary from what is shown in the manual. The bolts must be properly tightened as recommended for the hardware.

GAS CONNECTION

⚠️ WARNING

Use a new CSA International approved gas supply line.

Install a shut-off valve.

Securely tighten all gas connections.



**FIRE AND
EXPLOSION HAZARD**

If connected to LP, have a qualified person make sure gas pressure does not exceed the maximum pressure listed in the "Gas Supply Requirement" section.

Examples of a qualified person include:

- Licensed heating personnel
- Authorized gas company personnel
- Authorized service personnel

Failure to do so can result in death, explosion or fire.

This appliance shall be installed only by authorized persons and in accordance with the manufacturer's installation instructions, local gas fitting regulations, municipal building codes, electrical wiring regulations, local water supply regulations. The agency performing this work assumes responsibility for the quality of work performed, including checking for leaks and ensuring installation meets code requirements.

This range is factory-set for use with Natural gas. To use this range with Propane gas, see the "GAS CONVERSION" section before connecting this range to the gas supply. Gas conversions from Natural gas to Propane gas or from Propane gas to Natural gas must be done by a qualified installer.

TYPICAL FLEXIBLE CONNECTION

1. Apply pipe-joint compound made for use with LP gas to the smaller thread ends of the flexible connector adapters.

2. Attach one adapter to the gas pressure regulator and the other adapter to the gas shutoff valve. Tighten both adapters, being certain not to move or turn the gas pressure regulator.

3. Use a 15/16" (2.4 cm) combination wrench and channel lock pliers to attach the flexible connector to the adapters. Check that connector is not kinked.

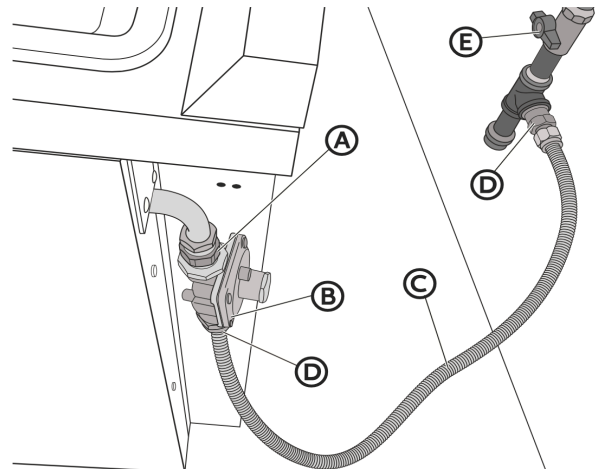

- (A) Adapter (provided)
- (B) Gas Pressure Regulator
- (C) Gas Supply Line
- (D) Adapters (From Gas Supply Line Kit)
- (E) Gas Shutoff Valve

TYPICAL RIGID PIPE CONNECTION	
<p>A combination of pipe fittings must be used to connect the range to the existing gas line. Your connections may be different, according to the supply line type, size and location.</p>	
<p>1. Apply pipe-joint compound made for use with LP gas to all pipe thread connections.</p>	
<p>2. Using a pipe wrench to tighten, connect the gas supply to the range.</p>	
<p> A Gas Line from Range B Washer (provided) C Adapter (provided) D Gas Pressure Regulator (provided) </p>	

CONVERT TO LP GAS (OPTIONAL)
<p>This range is shipped from the factory set up to use natural gas. It can be converted to use LP gas by a qualified service technician.</p>
<p>The LP conversion kit is packed in the oven. The conversion to LP requires all surface burner orifices and, if applicable, gas oven orifices to be changed. In addition, the nozzle on the gas pressure regulator needs to be reversed.</p>
<p>See "GAS CONVERSION" section for detailed instructions.</p>
<p>NOTE: All replaced orifices must be left with the consumer, including the instructions and retrofit sizes and orifice indication.</p>

COMPLETE CONNECTION	⚠ WARNING
Disconnect power before servicing.	 <p>ELECTRICAL SHOCK HAZARD</p>
Plug into a grounded 3-prong outlet.	
Do not use an adapter or an extension cord.	
Failure to do so can result in death, fire, or electrical shock	



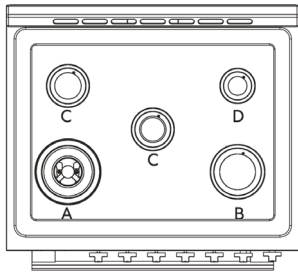

- 1** Open the manual shutoff valve in the gas supply line. The valve is open when the handle is parallel to the gas pipe.
- 2** Test all connections by brushing on an approved noncorrosive leak-detection solution. If bubbles appear, a leak is indicated. Correct any leak found.
- 3** Remove, if any, packaging tapes securing the burners on the surface. If the cooktop burner bases and caps are not pre-installed, remove them from package containing parts, align and place the burner bases and caps accordingly.



- (A)** Triple Ring (X-Large)
- (B)** Rapid (Large)
- (C)** Semi Rapid (Medium)
- (D)** Auxiliary (Small)

NOTE:

Align notches in burner caps with pins in burner base. Burner caps should be level when properly positioned. If burner caps are not properly positioned, surface burners will not light.

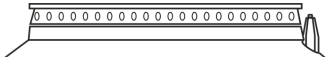
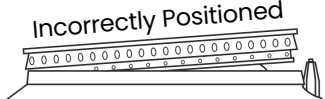
Cap	Base	Auxiliary Burner Semi Rapid Burner Rapid Burner	Triple Ring Burner
			
<p>Correctly Positioned</p> 		<p>Incorrectly Positioned</p> 	

- 4** Place burner grates over burners and caps.
- 5** Plug in range or reconnect power.

ADJUST FLAME HEIGHT

Check and adjust the height of top burner flames. The cooktop “low” burner flame should be a steady blue flame approximately 1/4” (6 mm) high. Propane gas flames have a slightly yellow tip.

Low Flame

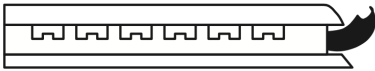

High Flame

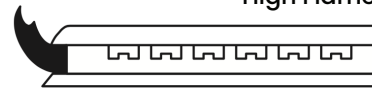

If burners do not light properly:

- ① Turn burner control knob to the “OFF” position.
- ② Check that the range is plugged in. Check that the circuit breaker has not tripped or the household fuse has not blown.
- ③ Check that the gas shutoff valves are set to the “open” position.
- ④ Check that burner caps are properly positioned on burner bases.

IMPORTANT

Adjustments must be made with two other burners in operation on a medium setting. This prevents the upper row of flames from being set too low, resulting in the flame being extinguished when other burners are turned on.

TO ADJUST STANDARD BURNER:

The flame can be adjusted using the adjustment screw in the center of the valve stem. The valve stem is located directly behind the control knob.

- ① Light the burner and turn the knob to the lowest setting (MIN).
- ② Pull and remove the control knob.
- ③ Insert a small, flat-blade screwdriver into the adjustment screw, and slowly turn the screw until the flame appearance is correct.
 - Open the valve more if the flames are too small or fluttered.
 - Close the valve more if the flames are too large.
- ④ Replace the control knob.
- ⑤ Test and check the flame by turning the control knob from the lowest to the highest settings.

- Ⓐ Adjustment Screw Ⓑ Control Knob Stem
Ⓒ Silkscreen of knob

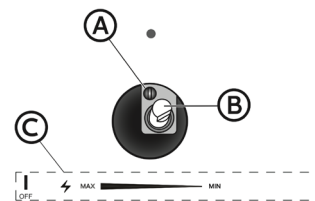

NOTE:

For burners (on some models) with safety valve, make sure that the regulation obtained is sufficient to maintain heating of the thermocouple. If it is not, increase the minimum flame.

ABNORMAL OPERATION

ANY OF THE FOLLOWING ARE CONSIDERED TO BE ANBORMAL OPERATION
AND MAY REQUIRE SERVICING:

- Yellow tipping of the hob burner flame.
- Sooting up of cooking utensils.
- Burners not igniting properly.
- Gas valves, which are difficult to turn.
- Burners failing to remain lit.
- Burners extinguished by oven door.

IN CASE THE APPLIANCE FAILS TO OPERATE CORRECTLY, CONTACT THE
AUTHORIZED SERVICE PROVIDE IN YOUR AREA.

THE BURNERS REQUIRE NO REGULATION OF THE PRIMARY AIR.

PLACEMENT AND LEVELING RANGE**IMPORTANT**

Do not operate the range if its rear foot is not completely engaged in the anti-tip bracket. Never completely remove the leveling legs or the range will not be secured to the anti-tip device properly.

- ① Slide range into final location, making sure rear leveling leg slides into the anti- tip bracket. Leave a 1" (2.5 cm) gap between the back of the range and the back wall.
- ② Check that the range is level by placing a level on the oven bottom. If needed, use a wrench to adjust the height of the leveling legs until the range is level from side to side and from front to back.

NOTE:

For burners (on some models) with safety valve, make sure that the regulation obtained is sufficient to maintain heating of the thermocouple. If it is not, increase the minimum flame.

VERIFY ANTI-TIP BRACKET ENGAGEMENT

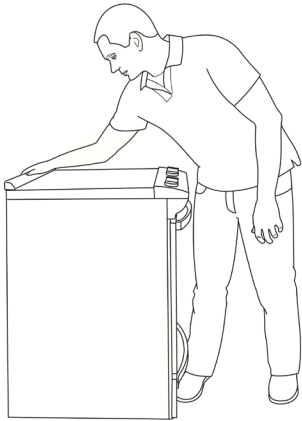

- ① Place the outside of your foot against the bottom of the front panel to keep the range from moving, and then grasp the back of the range, as shown.
- ② Slowly attempt to tilt the range forward.
 - If you encounter immediate resistance, the range foot is engaged in the anti-tip bracket. Range installation is completed.
 - If the rear of the range lifts more than 1/2" (1.3 cm) off the floor without resistance, stop tilting the range and lower it gently back to the floor. The range foot is not engaged in the anti-tip bracket. Proceed to Steps 3 and 4.

IMPORTANT

If the range is pulled away from the wall for any reason, always verify anti-tip bracket engagement again.

If there is a snapping or popping sound when tilting the range, the range may not be fully engaged in the bracket. Check to see if there are obstructions keeping the range from sliding to the wall or keeping the range foot from sliding into the bracket. Verify that the bracket is held securely in place by the mounting screws.

- ③ Slide the range forward, and verify that the anti-tip bracket is securely attached to the floor or wall.
- ④ Slide range back so the rear range foot is inserted into the slot of the antitip bracket.

NOTE:

For burners (on some models) with safety valve, make sure that the regulation obtained is sufficient to maintain heating of the thermocouple. If it is not, increase the minimum flame.

The range must be level for optimum cooking and baking performance.

GAS CONVERSION

GAS CONNECTION

⚠ WARNING

- Use a new CSA International approved gas supply line.
- Install a shut-off valve.
- Securely tighten all gas connections.

EXPLOSION HAZARD

If connected to LP, have a qualified person make sure gas pressure does not exceed 14" (36 cm) water column.

Examples of a qualified person include:

- Licensed heating personnel
- Authorized gas company personnel
- Authorized service personnel

Failure to do so can result in death, explosion or fire.

⚠ WARNING



- A child or adult can tip the range and be killed.
- Install anti-tip bracket to floor or wall per installation instructions.
- Slide range back so rear range foot is engaged in the slot of the anti-tip bracket.
- Re-engage the anti-tip bracket if range is moved.
- Do not operate the range without anti-tip bracket installed and engaged.
- Failure to follow these instructions can result in death or serious burns to children and adults

GAS CONVERSION

LP/PROPANE GAS CONVERSION

IMPORTANT

Gas conversions must be done by a qualified service technician in accordance with the manufacturer's instructions and all codes and requirements of the authority having jurisdiction. The qualified agency performing this work assumes the gas conversion responsibility.

Convert Gas Pressure Regulator

- ① Turn manual shutoff valve to the closed position.
- ② Unplug range or disconnect power.
- ③ Locate the gas pressure regulator on the back of the range.
IMPORTANT: Do not remove the gas pressure regulator.

- ④ Unscrew the regulator cap with the wrench.

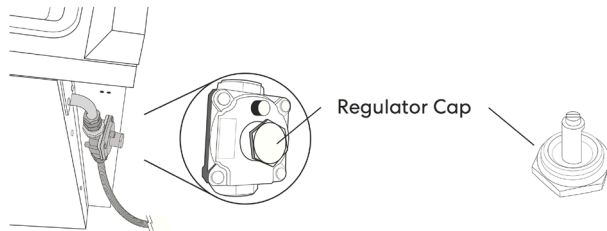

- ⑤ Remove the retainer pin that is currently positioned for use with natural gas.

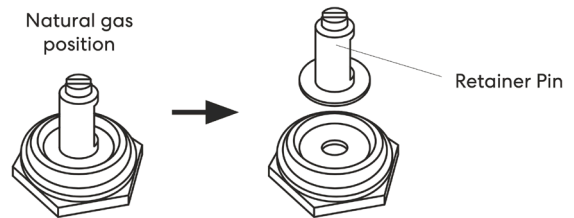

- ⑥ Turn the retainer pin upside down and place it back into the regular cap. The regular cap is now positioned for use with LP gas.

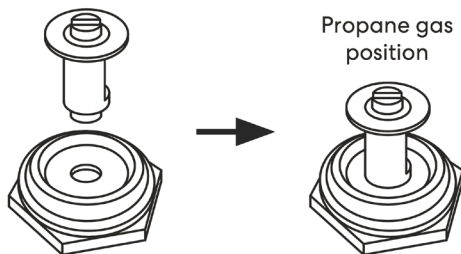

- ⑦ Screw and tighten the regulator cap back into the gas pressure regulator with the wrench.

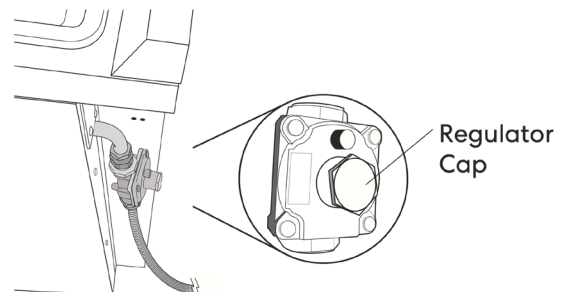

Convert Surface Burners

- ① If installed, remove the burner grates.
- ② Remove the burner grates, burner caps, and the burner base.

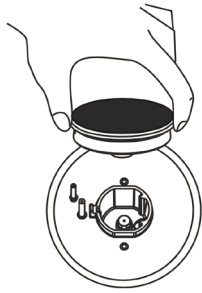

- ③ Remove the natural gas orifices with a 9/32" (7 mm) nut driver.

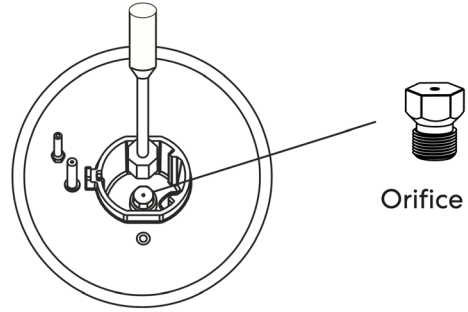

- ④ Replace the natural gas orifices with the correct LP gas orifices from the LP conversion kits. LP gas orifices are stamped with a size. Refer to the following chart for correct LP gas orifice ratings and sizes for proper placement.

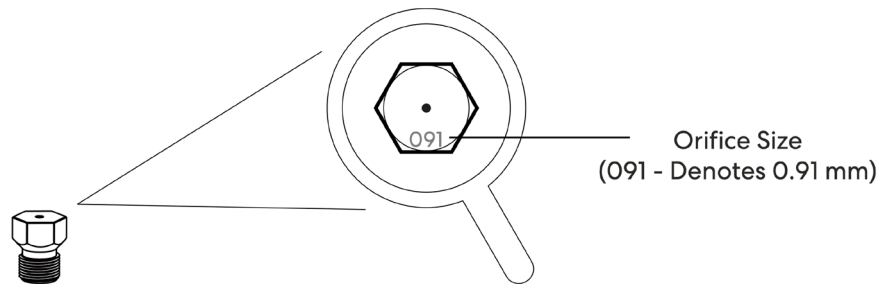

IMPORTANT: Keep and store the orifices that have just been replaced in case of re-installation with another gas.

- ⑤ Replace the burner base, the burner caps, and the burner grates.

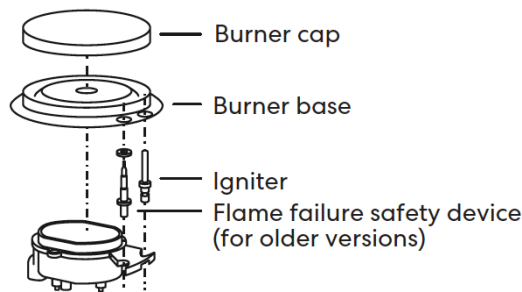

Orifice Chart for Surface and Oven Burners				
Burner	Placement	Orifice Type	Orifice Size (mm)	Burner Rating
Triple Ring	Front Left	NG	2.10	18,000 BTU
		LP	1.22	17,000 BTU
Rapid	Front Right	NG	1.45	8,800 BTU
		LP	0.91	
Semi Rapid	Center	NG	1.29	6,900 BTU
		LP	0.80	
Semi Rapid	Rear Left	NG	1.29	6,900 BTU
		LP	0.80	
Auxiliary	Rear Right	NG	1.05	5,000 BTU
		LP	0.70	
Broil	Oven Top	NG	1.40	8,500 BTU
		LP	0.83	
Bake	Oven Bottom	NG	1.85	14,000 BTU
		LP	1.10	

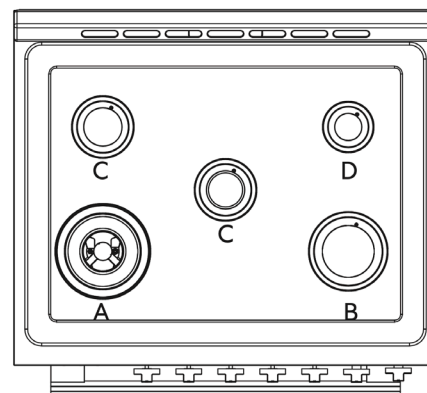

- Ⓐ Triple Ring (X-Large)
- Ⓑ Rapid (Large)
- Ⓒ Semi Rapid (Medium)
- Ⓓ Auxiliary (Small)

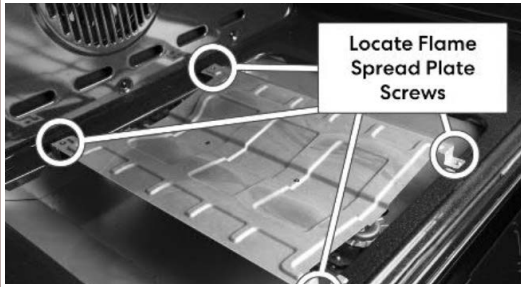
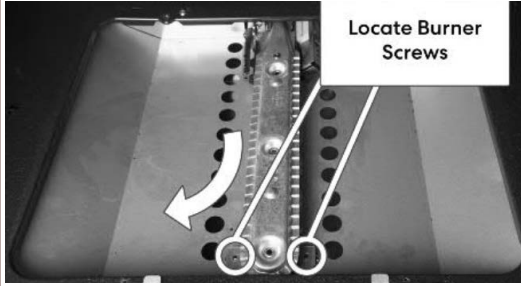
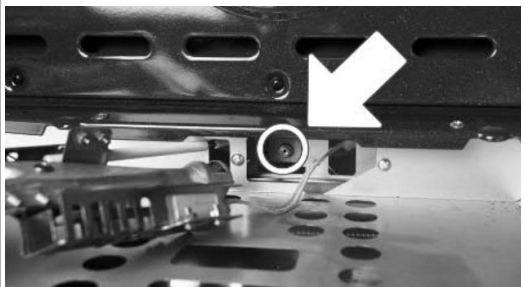
Convert Oven Bake Burner	
<p>This product cannot be converted to Natural gas or LP gas by adjusting or tightening the oven orifices. The orifices must be replaced.</p>	
<p>①</p> <p>Remove Bake Burner Cover</p> <p>Open your oven door and unscrew the back two screws of bake burner cover. Remove the bake burner cover.</p>	
<p>②</p> <p>Remove Flame Spread Plate</p> <p>Unscrew the four screws of the flame spread plate. Remove the flame spread plate.</p>	
<p>③</p> <p>Slide Out Burner</p> <p>Unscrew the front two screws holding the burner in place. Slide out the burner up and towards oven door out of the socket, careful not to sever or pull on the wire.</p>	
<p>④</p> <p>Change the Burner Orifice</p> <p>Move the burner carefully to gain access to the burner orifice, careful not to sever or pull on the wire. Proceed with changing the orifice.</p>	

Convert Oven Broil Burner

①

Unscrew Front Bracket

Locate the bracket at the front of the broiler.
Remove the screw.



②

Remove the Burner

Carefully slide the burner forward and out of the socket, without severing or damaging the wire attached. Carefully lay the burner down as shown in the image to the right.



③

Change the Burner Orifice

With the burner out of the way look for the orifice as shown. Continue with changing the orifice.



Complete Gas Conversion

① Open shutoff valve in the gas supply line.

② Plug in cooktop or reconnect power.

- Refer to "Gas Connection" section in the "Installation Instructions" section for proper connection of the range to the gas supply.

- Refer to "Complete Connection" section to complete this procedure.

- Refer to the "Adjust Flame Height" section for burner flame adjustments.

IMPORTANT: Do not remove the gas pressure regulator.

You may have to adjust the low setting for each cooktop burner.

Correct Disposal of this Product

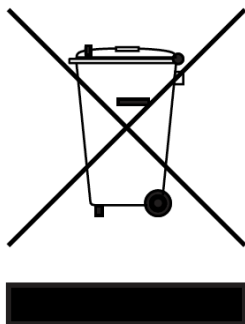

This marking indicates that this appliance should not be disposed with other household wastes. To prevent possible harm to the environment or human health from uncontrolled waste disposal, recycle it responsibly to promote the sustainable reuse of material resources.

IMPORTANT SAFETY INSTRUCTIONS

⚠ WARNING

To reduce the risk of fire, electrical shock, injury to persons, or damage when using the range, follow basic precautions, including the following:

- | | |
|---|--|
| <ul style="list-style-type: none">• WARNING: TO REDUCE THE RISK OF TIPPING OF THE RANGE, THE RANGE MUST BE SECURED BY PROPERLY INSTALLED ANTI-TIP DEVICES. TO CHECK IF THE DEVICES ARE INSTALLED PROPERLY, SLIDE RANGE COMPLETELY FORWARD, LOOK FOR ANTI-TIP BRACKET SECURELY ATTACHED TO THE FLOOR OR WALL, AND SLIDE RANGE BACK SO THE REAR RANGE FOOT IS UNDER ANTITIP BRACKET.• WARNING: NEVER use this appliance as a space heater to heat or warm the room. Doing so may result in carbon monoxide poisoning and overheating of the oven.• WARNING: NEVER cover any slots, holes or passages in the oven bottom or cover an entire rack with materials such as aluminum foil. Doing so blocks airflow through the oven and may cause carbon monoxide poisoning. Aluminum foil linings may also trap heat, causing a fire hazard. | <ul style="list-style-type: none">• CAUTION: Do not store items of interest to children in cabinets above a range or on the back guard of a range – children climbing on the range to reach items could be seriously injured.• Do Not Leave Children Alone – Children should not be left alone or unattended in area where range is in use. They should never be allowed to sit or stand on any part of the range.• Wear Proper Apparel – Loosefitting or hanging garments should never be worn while using the range.• User Servicing – Do not repair or replace any part of the range unless specifically recommended in the manual. All other servicing should be referred to a qualified technician.• Storage in or on Range – Flammable materials should not be stored in an oven or near surface units.• This appliance is not intended for storage. |
|---|--|

READ AND SAVE THESE INSTRUCTIONS

IMPORTANT SAFETY INSTRUCTIONS

- Do Not Use Water on Grease Fires – Smother fire or flame or use dry chemical or foam-type extinguisher.
- Use Only Dry Potholders – Moist or damp potholders on hot surfaces may result in burns from steam. Do not let potholder touch hot heating elements. Do not use a towel or other bulky cloth.
- Never Leave Surface Units Unattended at High Heat Settings – Boilover causes smoking and greasy spillovers that may ignite.
- Glazed Cooking Utensils – Only certain types of glass, glass/ceramic, ceramic, earthenware, or other glazed utensils are suitable for rangetop service without breaking due to the sudden change in temperature.
- Utensil Handles Should Be Turned Inward and Not Extend Over Adjacent Surface Units – To reduce the risk of burns, ignition of flammable materials, and spillage due to unintentional contact with the utensil, the handle of a utensil should be positioned so that it is turned inward, and does not extend over adjacent surface units.
- Disconnect power before servicing.
- Proper Installation – The appliance, when installed, must be electrically grounded in accordance with local codes, or in the absence of local codes, with the National Electrical Code, ANSI/NFPA 70 or the Canadian Electrical Code, CSA C22.1-02. In Canada, the appliance must be electrically grounded in accordance with Canadian Electrical Code. Be sure your appliance is properly installed and grounded by a qualified technician.
- Injuries may result from misuse of appliance doors or drawers such as stepping, leaning, or sitting on the doors or drawers.
- Maintenance – Keep range area clear and free from combustible materials, gasoline, and other flammable vapors and liquids.
- Do not let cooking grease or other flammable materials accumulate in or near the range. Grease in the oven or on the cooktop may ignite.
- Top burner flame size should be adjusted so it does not extend beyond the edge of the cooking utensil. This instruction is based on safety considerations.

READ AND SAVE THESE INSTRUCTIONS

IMPORTANT SAFETY INSTRUCTIONS

- Do not use replacement parts that have not been recommended by the manufacturer (e.g. parts made at home using a 3D printer).
- Clean Cooktop With Caution – If a wet sponge or cloth is used to wipe spills on a hot cooking area, be careful to avoid steam burn. Some cleaners can produce noxious fumes if applied to a hot surface.
- Use Care When Opening Door – Let hot air or steam escape before removing or replacing food.
- Do Not Heat Unopened Food Containers – Build-up of pressure may cause container to burst and result in injury.
- Keep Oven Vent Ducts Unobstructed.
- Never broil with door open. Open-door broiling is not permitted due to overheating of control knobs.
- Placement of Oven Racks – Always place oven racks in desired location while oven is cool. If rack must be moved while oven is hot, do not let potholder contact hot heating element in oven.
- Care must be taken to prevent aluminum foil and meat probes from contacting heating elements.
- DO NOT TOUCH HEATING ELEMENTS OR INTERIOR SURFACES OF OVEN – Heating elements may be hot even though they are dark in color. Interior surfaces of an oven become hot enough to cause burns. During and after use, do not touch, or let clothing or other flammable materials contact heating elements or interior surfaces of oven until they have had sufficient time to cool. Other surfaces of the appliance may become hot enough to cause burns – among these surfaces are cooktop, burners, grates, oven vent openings and surfaces near these openings, oven doors, windows of oven doors, and crevices around the oven doors.
- Top burner flame size should be adjusted so it does not extend beyond the edge of the cooking utensil.
- Have the installer show you the location of the range gas shutoff valve and how to turn it off if necessary.

READ AND SAVE THESE INSTRUCTIONS

IMPORTANT SAFETY INSTRUCTIONS

- Proper Disposal of Your Appliance – Dispose of or recycle your appliance in accordance with Federal and Local Regulations. Contact your local authorities for the environmentally safe disposal or recycling of your appliance.

For units with ventilating hood

- Clean Ventilating Hoods Frequently – Grease should not be allowed to accumulate on hood or filter.
- When flambé cooking or cooking with high heat under the vent hood, always turn the fan on.

For self-cleaning ranges

- Do Not Clean Door Gasket – The door gasket is essential for a good seal. Care should be taken not to rub, damage, or move the gasket.
- Do Not Use Oven Cleaners – No commercial oven cleaner or oven liner protective coating of any kind should be used in or around any part of the oven.
- Clean Only Parts Listed in Manual.
- Before Self-Cleaning the Oven – Remove broiler pan and other utensils. Wipe off all excessive spillage before initiating the cleaning cycle.

READ AND SAVE THESE INSTRUCTIONS

OVERVIEW

RANGE LAYOUT

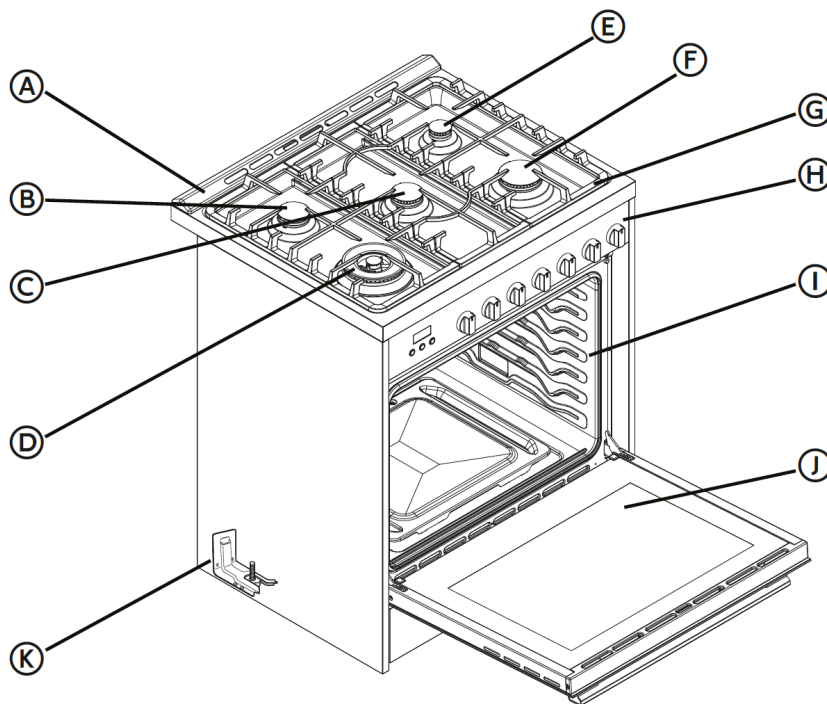

This illustration covers several different models. The range you have purchased may have some or all of the items listed. The locations and appearances of the features shown here may not match those of your model.

- | | |
|------------------------|--------------------------|
| (A) Backsplash | (G) Surface burner grate |
| (B) Semi-rapid burner | (H) Control panel |
| (C) Semi-rapid burner | (I) Oven rack positions |
| (D) Triple ring burner | (J) Oven door window |
| (E) Auxiliary burner | (K) Anti-tip bracket |
| (F) Rapid burner | |

WHAT'S INCLUDED

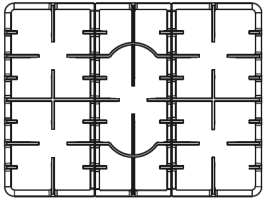

Surface burner grates
(3)



Surface burners and
caps (5)

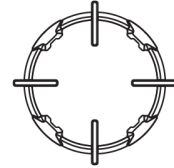

Wok grate

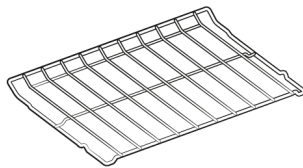

Oven racks (2)

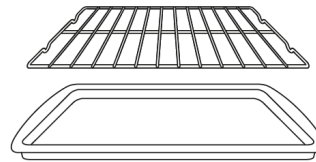

Baking tray and flat
rack

BURNER LAYOUT

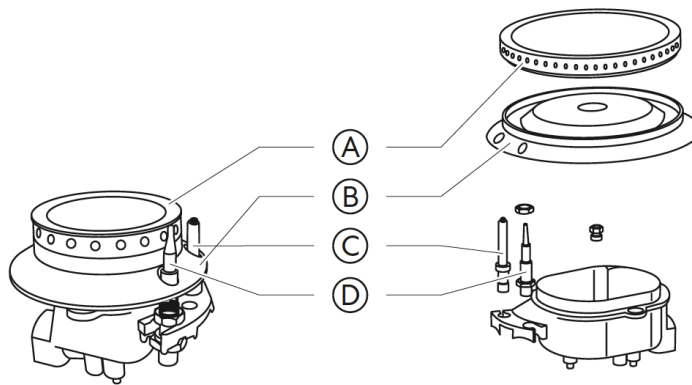

(A) Burner cap

(B) Burner head

(C) Electrode

(D) Flame failure safety device
(on older models)

CONTROL PANEL

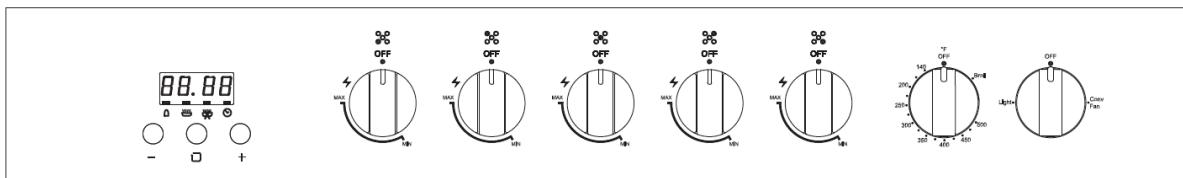

Clock/Timer Controls

Surface Burner Controls

Oven Controls

CLOCK & TIMER

SETTING THE CLOCK AND TIMER

IMPORTANT

Clock must be set in order for the timed oven functions to work.
Your model has a digital display clock with 3 control buttons.

TO SET THE TIME OF DAY

When the power is connected or after a power outage, the screen will display 12.00 and the indicator bar above ☺ "Set Clock" will blink.

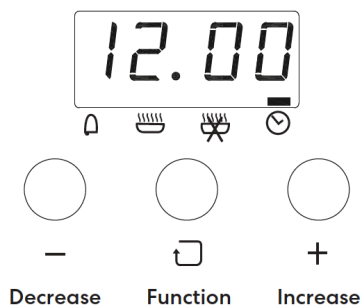

- ① If the clock was previously set, press the function button repeatedly until the indicator bar blinks above ☺ "Set Clock".
- ② Press or hold the + or - button to adjust the clock. The clock will be confirmed automatically if you leave the correct time there for 5 seconds without pressing any buttons, and the indicator bar will become solid. You may also press the function button to confirm the clock manually while the indicator bar is blinking.

TO SET THE TIMER

The digital countdown timer can be set up to 11 hours and 59 minutes maximum.

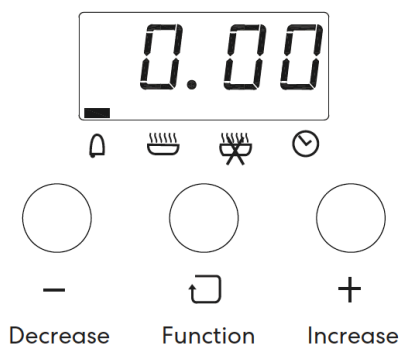

- ① Press the function button repeatedly until the indicator bar blinks above "Timer Set".
- ② Press or hold the + or - button to set the length of time, then press the function button or wait for 5 seconds to confirm.
- ③ Once confirmed, the current time will be shown and the countdown will begin. When the countdown is finished, press any button to stop the beeping.

To view and modify the countdown time remaining, press the function button once to select  "Timer Set" again and use the + or - button to adjust the current timer as needed; To cancel the timer, follow the steps above to set the length of time to 0.00.

NOTE:

When adjusting the time, idling for 5 seconds without pressing any buttons will automatically confirm the current time on the display.

TIMED COOKING

WARNING

FOOD POISONING HAZARD

- Do not let food sit in oven more than one hour before or after cooking.
- Doing so can result in food poisoning or sickness.
- Foods that can easily spoil such as milk, eggs, fish, meat or poultry, should be chilled in the refrigerator first. Even when chilled, they should not stand in the oven for more than 1 hour before cooking begins, and should be removed promptly when finished cooking.

Set Cook Time Only:

Cook for the set length of time from now, then shut off the oven automatically.

Set End Time Only:

Shut off the oven automatically at the set time of day.

NOTE:

- Clock must be set in order for the timed oven functions to work.
- Only one of Cook Time and End Time can be used at a time.

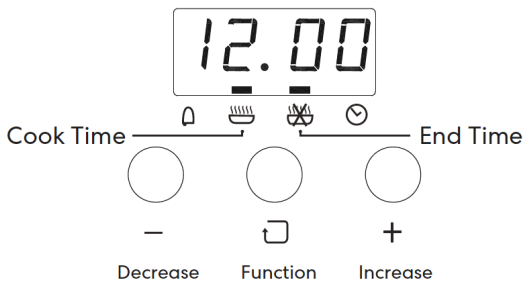

• TO SET THE COOK TIME:

Press the function button until the bar flashes above "Cook Time". Then use the + or - button to set the length of cooking time (maximum of 10 hours), and press the function button or wait for 5 seconds to confirm.

• TO SET THE END TIME:

Press the function button until the bar flashes above "End Time". Then use the + or - button to set the shut off time of day, and press the function button or wait for 5 seconds to confirm.

SETTING THE COOKING METHODS

The appearance of the knobs may vary from what is shown in the manual.

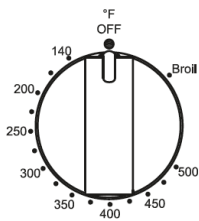

Thermostat (°F)

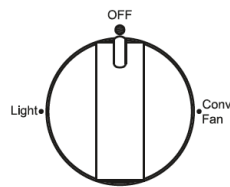

Cooking Mode

Turn the oven Thermostat knob and Cooking-Mode knobs to set the temperature and oven mode. The oven will turn on, and will automatically shut off according to the time set. When the shut off time is reached, press any button to stop the beeping and return the oven knobs to the OFF position.

EXAMPLE:

Start/Continue baking at 350°F for 50 minutes and finish cooking at 6:00.

- 1 Press the function button repeatedly until the indicator bar blink above "Cook Time", then set the length of cooking time to 0.50 and confirm. **OR** Press the function button repeatedly until the indicator bar blink above "End Time", then set the shut off time of day to 6.00 and confirm.
- 2 Turn/Keep the thermostat knob at 350°. Once the clock time is returned on the display, the indicator bar above "Cook Time" or "End Time" will be blinking, indicating a schedule is set.
- 3 At 6:00 when the cooking is finished, the oven will shut down automatically. Press any button to stop the beeping, and turn the oven knobs to the OFF position.

COOKTOP USE

Read the instructions before installing or using this appliance.

- This appliance shall be installed in accordance with the regulations in force and only used in a well-ventilated space.
- The use of a gas-cooking appliance results in the production of heat and moisture in the room in which it is installed. Ensure that the kitchen is well ventilated: keep natural ventilation holes open or install a mechanical ventilation device (mechanical extractor hood).
- Prolonged intensive use of the appliance may call for additional ventilation, for example opening of a window, or more effective ventilation, for example increasing the level of mechanical ventilation where present.

IGNITION AND OPERATION OF THE BURNERS

To ignite a burner, push down on the burner knob and rotate it counterclockwise until the knob indicator is aligned with the ⚡ ignite icon. Release the knob and adjust the flame intensity by further rotating the knob counterclockwise from MAX (maximum) to MIN (minimum).

To turn off the burner, rotate the knob clockwise until the indicator on the knob is aligned with OFF.

NOTE:

For models with a flame failure safety device - Once the flame is lit, hold the knob depressed for about 3-4 seconds until the device keeps the burner automatically lit. If the burner fails to ignite, wait one minute for the gas to dissipate before attempting to reignite.

POWER FAILURE

- In case of prolonged power failure, the surface burners can be lit manually. Hold a lit match near a burner and turn knob counterclockwise until the indicator is aligned with MAX. After the burner is lit, turn knob to desired setting.
- The electric igniter must not be actuated for longer than 15 seconds. Should the burner not light, or should the burner be unintentionally turned off, immediately close the burner, and wait at least 1 minute before repeating. Once ignited, adjust the flame as desired.
- In the case of unintentional flame extinguishing, the safety valve intervenes by shutting off the gas to the burners. For lower gas consumption and a better result, use saucepans with a diameter matching the diameter of the burner, to avoid the flame coming up around the sides of the saucepan. See the Container Table. Use only flatbottomed pans.
- As soon as liquid starts to boil, turn the flame down to a level sufficient to maintain boiling.

COOKWARE

MATCH PAN DIAMETER TO FLAME SIZE

The flame should be the same size as the bottom of the pan or smaller. Do not use small pans with high flame settings as the flames can lick up the sides of the pan. Oversized pans that span two burners are placed front to rear, not side to side.

USE BALANCED PANS -

Pans must sit level on the cooktop grate without rocking. Center the pan over the burner.

USE A LID THAT FITS PROPERLY -

A well-fitting lid helps shorten the cooking time. Flat, heavy bottom pans provide even heat and stability.

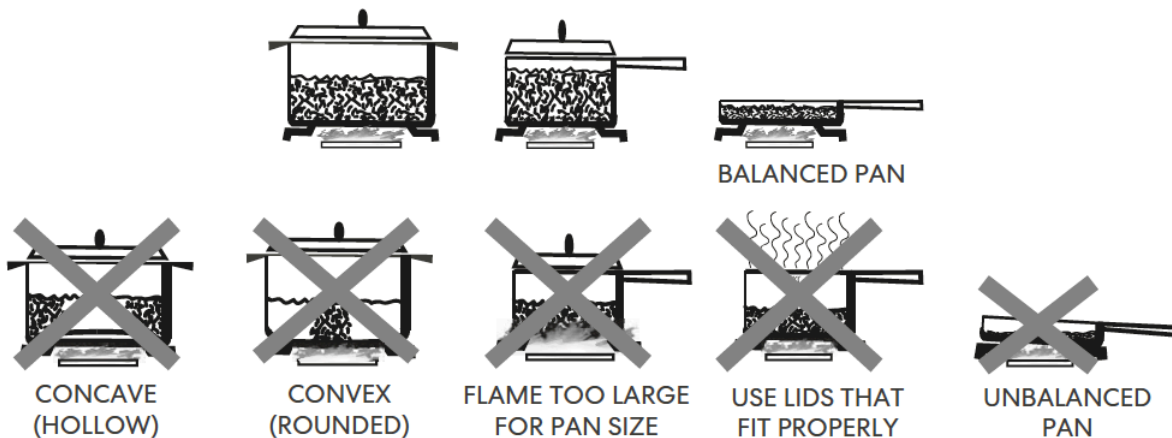

CONTAINER TABLE

BURNER	MIN SAUCEPAN	MAX SAUCEPAN
Auxiliary	3.5" (9.0cm)	6.3" (16cm)
Semi-rapid	5.1" (13cm)	7.1" (18cm)
Rapid	5.9" (15cm)	10.2" (26cm)
Triple Ring	8.3" (21cm)	10.2" (26cm)

OVEN USE

⚠ WARNING

NEVER cover any slots, holes or passages in the oven bottom or cover an entire rack with materials such as aluminum foil. Doing so blocks airflow through the oven and may cause carbon monoxide poisoning. Aluminum foil linings may also trap heat, causing a fire hazard.

Reset all controls to the OFF position after using a programmable timing operation. No attempt should be made to operate the appliance during power failure.

An air curtain or other overhead range hood, which operates by blowing a downward airflow onto a range shall not be used in conjunction with a gas range.

OVEN CONTROLS

The Thermostat knob and Cooking-mode knobs are used together to select Oven Modes. The appearance of the knobs may vary from what is shown in the manual.

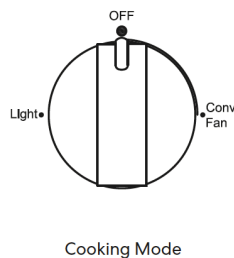
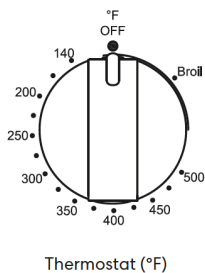

PUSH IN THERMOSTAT KNOB

Push in on the Thermostat knob, and then turn the knob to any baking temperature or broil to automatically ignite the bake burner or the broil burner.

Bake

THERMOSTAT RANGE: 140°F (60°C) TO MAX 500°F (260°C)

The Bake mode uses heat from the lower element to cook food. When using this mode to prepare baked goods such as cakes, cookies and pastries, always preheat the oven first and place food centrally near the middle racks.

Broil

THERMOSTAT RANGE: Broil

The Broil mode uses intense heat from the upper element to sear foods. Ideal for toasting, melting cheese, browning and searing surface. Food should be placed near the upper racks, and should not be cooked for too long on each side of the food. It is not necessary to preheat when using this mode.

NOTE:

Except for timed cooking, the oven will remain on until the Thermostat knob is returned to the OFF position.

COOKING MODE KNOBS

Light

The Light mode turns on oven light inside the oven.

Conv Fan (Convection Fan)

The Convection Fan mode uses air movement from the fan to improve heat distribution and enhance cooking evenness within the oven. Cooking times may be slightly longer for multiple racks than what would be expected for a single rack.

NOTE:

The convection fan turns on for Bake mode only.

TIPS AND TECHNIQUES

Bake

Baking is cooking with heated air. Both upper and lower elements in the oven are used to heat the air but no fan is used to circulate the heat. Follow the recipe or convenience food directions for baking temperature, time and rack position. Baking time will vary with the temperature of ingredients and the size, shape and finish of the baking utensil.

General Guidelines

- For best results, bake food on a single rack with at least 1" - 1½" (2.5 - 3 cm) space between utensils and oven walls.
- Use one rack when selecting the bake mode.
- Check for doneness at the minimum time.
- Use metal bake ware (with or without a non-stick finish), heatproof glass, glass-ceramic, pottery or other utensils suitable for the oven.
- When using heatproof glass, reduce temperature by 25°F (15°C) from recommended temperature.
- Use baking sheets with or without sides or jelly roll pans.
- Dark metal pans or nonstick coatings will cook faster with more browning. Insulated bake ware will slightly lengthen the cooking time for most foods.
- Do not use aluminum foil or disposable aluminum trays to line any part of the oven. Foil is an excellent heat insulator and heat will be trapped beneath it. This will alter the cooking performance and can damage the finish of the oven.
- Avoid using the opened door as a shelf to place pans.
- See Troubleshooting for tips to Solving Baking and Roasting Problems.

BAKE CHART

FOOD ITEM	RACK POSITION	TEMP. °F (°C) (PREHEATED OVEN)	TIME (MIN)
Cake			
Cupcakes	2	350 (175)	19-22
Bundt Cake	1	350 (175)	40-45
Angel Food	1	350 (175)	35-39
Pie			
2 crust, fresh, 9"	2	375-400 (190-205)	45-50
2 crust, frozen fruit, 9"	2	375 (190)	68-78
Cookies			
Sugar	2	350-375 (175-190)	8-10
Bundt Cake	2	350-375 (175-190)	8-13
Angel Food	2	350 (175)	29-36
Breads			
Yeast bread loaf, 9x5	2	375 (190)	18-22
Yeast rolls	2	375-400 (190-205)	12-15
Biscuits	2	375-400 (190-205)	7-9
Muffins	2	425 (220)	15-19
Pizza			
Frozen	2	400-450 (205-235)	23-26
Fresh	2	475 (246)	15-18

RANGE CARE

CLEANING

IMPORTANT

Before cleaning, make sure all controls are off and the oven and cooktop are cool. Always follow label instructions on cleaning products. Soap, water and a soft cloth or sponge are suggested first unless otherwise noted. Do not use abrasive cleaning products.

EXTERIOR PORCELAIN ENAMEL SURFACES

Food spills containing acids, such as vinegar and tomato, should be cleaned as soon as the entire appliance is cool. These spills may affect the finish.

Cleaning Method:

- Glass cleaner, mild liquid cleaner or nonabrasive scrubbing pad: Gently clean around the model and serial number plate because scrubbing may remove numbers.

EXTERIOR STAINLESS STEEL

Rub in direction of grain to avoid damaging.

Cleaning Methods:

- Liquid detergent or all-purpose cleaner: Rinse well with clean water and dry with soft, lint-free cloth.
- Stainless Steel Cleaner and Polish. Vinegar for hard water spots.

NOTE:

Do not use soap-filled scouring pads, abrasive cleaners, Cooktop Polishing Cream, steel-wool pads, gritty washcloths or some paper towels. Damage may occur, even with one-time or limited use.

OVEN DOOR EXTERIOR

Cleaning Method:

- Glass cleaner and paper towels or nonabrasive plastic scrubbing pad: Apply glass cleaner to soft cloth or sponge, not directly on panel.

PORCELAIN-COATED GRATES AND CAPS

- Clean as soon as cooktop, grates and caps are cool.
- Food spills containing acids, such as vinegar and tomato, should be cleaned as soon as the cooktop grates and caps are cool. These spills may affect the finish.
- To avoid chipping, do not bang grates and caps against each other or hard surfaces such as cast iron cookware.
- Do not reassemble caps on burners while wet.

Cleaning Method:

- Nonabrasive plastic scrubbing pad and mildly abrasive cleanser.

BURNER SPREADER

Cleaning Methods:

- Wash the burner spreader frequently with boiling water and detergent to remove any deposits which could block the flame outlet.
- Before reinstalling, dry the burner spreader thoroughly so the burner will ignite properly.

PORCELAIN-COATED GRATES AND CAPS

- Pull knobs straight away from control panel to remove.
- When replacing knobs, make sure knobs are in the Off position.

Cleaning Method:

- Soap and water or dishwasher.

NOTE:

Do not use steel wool, abrasive cleansers or oven cleaner. Do not soak knobs.

CONTROL PANEL

Cleaning Methods:

- Glass cleaner and soft cloth or sponge: Apply glass cleaner to soft cloth or sponge, not directly on panel.

NOTE:

Do not use abrasive cleaners, steel-wool pads, gritty washcloths or some paper towels. Damage may occur.

OPEN CAVITY

- Food spills should be cleaned when oven cools. At high temperatures, foods react with porcelain, so staining, etching, pitting or faint white spots can result.

Cleaning Method:

- Mild detergent and warm water.

NOTE:

Do not use oven cleaners.

OVEN RACKS AND ROASTING RACKS

Cleaning Methods:

- Steel-wool pad

2-PIECE BAKING TRAY OR BROILER PAN

- Mildly abrasive cleanser: Scrub with wet scouring pad.
- Solution of ½ cup (125 mL) ammonia to 1 gal. (3.75 L) water: Soak for 20 minutes, and then scrub with scouring or steel-wool pad.
- Oven cleaner: Follow product label instructions.

Cleaning Method Porcelain enamel only, not chrome:

- Dishwasher.

TROUBLESHOOTING

First try the solutions suggested here to possibly avoid the cost of a service call.

BAKING PROBLEMS

With any oven setting poor results can occur for many reasons other than a malfunction of the oven. Check the chart below for causes of the most common problems. Since the size, shape and material of baking utensils directly affect the baking results, the best solution may be to replace old baking utensils that have darkened and warped with age and use.

PROBLEM	CAUSE
Food browns unevenly	<ul style="list-style-type: none"> • Oven not preheated • Aluminum foil on oven rack or oven bottom • Baking utensil too large for recipe • Pans touching each other or oven walls
Food too brown on bottom	<ul style="list-style-type: none"> • Oven not preheated • Using glass, dull or darkened metal pans • Incorrect rack position • Pans touching each other or oven walls
Food is dry or has shrunk excessively	<ul style="list-style-type: none"> • Oven temperature too high • Baking time too long • Oven door opened frequently • Pan size too large
Food is baking or roasting too slowly	<ul style="list-style-type: none"> • Oven temperature too low • Oven not preheated • Oven door opened frequently • Tightly sealed with aluminum foil • Pan size too small
Pie crusts do not brown on bottom or crust is soggy	<ul style="list-style-type: none"> • Baking time not long enough • Using shiny steel pans • Incorrect rack position • Oven temperature is too low
Cakes pale, flat and may not be done inside	<ul style="list-style-type: none"> • Oven temperature too low • Incorrect baking time • Cake tested too soon • Oven door opened too often • Pan size may be too large
Cakes high in middle with crack on top	<ul style="list-style-type: none"> • Oven temperature too high • Baking time too long • Pans touching each other or oven walls • Incorrect rack position • Pan size too small • Pan size may be too large
Pie crust edges too brown	<ul style="list-style-type: none"> • Oven temperature too high • Edges of crust too thin

COOKTOP PROBLEMS

PROBLEM	POSSIBLE CAUSE	SOLUTION
Burner will not ignite	There is no power to the range.	Make sure electrical plug is plugged into a live, properly grounded outlet. Replace the fuse or reset the circuit breaker.
Burner will not operate	First time use. Air still in the gas line.	Turn on any one of the surface burner knobs to release air from the gas lines.
	Control knob is not set correctly.	Push in knob before turning to a setting.
	The burner port is clogged.	Clean burner port opening using a stiff, nylon toothbrush or a straightened paper clip.
Burner Flames are uneven, yellow and/ or noisy	Burner port(s) are clogged.	Clean burner port opening using a stiff, nylon toothbrush or a straightened paper clip.
	Burner caps are not positioned properly.	Place burner caps so that the alignment pins are properly aligned with the slots.
	Propane gas is being used.	The range should be converted to LP gas by a qualified technician.
Burner flame is too high or too low	Cooktop gas supply is not correct.	Ensure the range is set for the correct gas type. It is factory set for natural gas. If connecting to LP gas, the burners should be converted to LP gas with the orifice kit supplied and the pressure regulator converted to the LP gas setting by a qualified technician.
	The gas pressure is not correct.	Make sure the pressure regulator is installed correctly and the gas line pressure is correct. See Installation Instructions.
Burner makes popping noises	The burner is wet.	Allow the burner to dry before using.
	The burner cap or gas spreader is not positioned correctly.	Place burner caps so that the alignment pins are properly aligned with the slots.
Excessive heat around cookware on cooktop	The cookware is not the proper size for the burner.	Use cookware with a bottom surface approximately the same size as the cooking area and burner. Cookware should not extend more than 1" (2.5 cm) outside the cooking area. Adjust the flame so that it does not come up around the cookware.
Cooking results are not what expected	Using incorrect cookware.	See the "Cookware" section.
	The control knob is not set to the proper heat level.	See the "Controls" section.

OVEN PROBLEMS

PROBLEM	POSSIBLE CAUSE	SOLUTION
Oven is not heating	No power to the range.	Check the circuit breaker or fuse box to your house. Make sure there is proper electrical power to the oven.
	Oven control not turned on.	Make sure the oven temperature has been selected.
Oven is not cooking evenly	Not using the correct bake ware or oven rack position.	Refer to cook charts for recommended rack position. Always reduce recipe temperature by 25 °F (15 °C) when baking with Convection Bake mode.
Oven display stays off	Power interruption.	Turn off power at the main power supply (fuse or breaker box). Turn breaker back on. If condition persists, call for service.
Cooling fan continues to run after oven is turned off	The electronic components have not yet cooled sufficiently.	The fan will turn off automatically when the electronic components have cooled sufficiently.
Oven light is not working properly	Light bulb loose or burned-out.	Reinsert or replace the light bulb. Touching the bulb with fingers may cause the bulb to burn out.
Oven light stays on	Door is not closing completely.	Check for obstruction in oven door. Check to see if hinge is bent or door switch broken.
Cannot remove lens cover	Soil build-up around the lens cover.	Wipe lens cover area with a clean, dry towel prior to attempting to remove the lens cover.
Clock and timer are not working properly	No power to the range.	Check the circuit breaker or fuse box to your house. Make sure there is proper electrical power to the oven.
Excessive Moisture		When using bake mode, preheat the oven first. Convection Bake and Convection Roast will eliminate any moisture in the oven.
Porcelain Chips	Porcelain interior is chipped by oven racks	When removing and replacing oven racks, always tilt racks upward and do not force them to avoid chipping the porcelain.

Rangaire

Correct Disposal of this Product

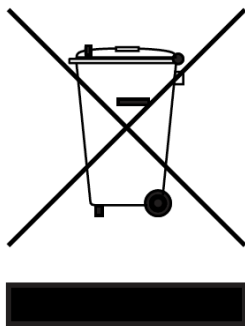

This marking indicates that this appliance should not be disposed with other household wastes. To prevent possible harm to the environment or human health from uncontrolled waste disposal, recycle it responsibly to promote the sustainable reuse of material resources.