

# User Guide

Lenovo  
**ThinkBook**



**Lenovo**

Lenovo ThinkBook 14 2-in-1 Gen 4

## **Read this first**

Before using this documentation and the product it supports, ensure that you read and understand the following:

- [Generic Safety and Compliance Notices](#)
- *Safety and Warranty Guide*
- *Setup Guide*

**First Edition (February 2024)**

**© Copyright Lenovo 2024.**

LIMITED AND RESTRICTED RIGHTS NOTICE: If data or software is delivered pursuant to a General Services Administration "GSA" contract, use, reproduction, or disclosure is subject to restrictions set forth in Contract No. GS-35F-05925.

---

# Contents

## About this guide . . . . . iii

## Chapter 1. Meet your computer . . . . . 1

Front . . . . .	1
Microphones . . . . .	1
Infrared LED . . . . .	2
Camera shutter . . . . .	2
Camera . . . . .	2
Camera light . . . . .	2
Screen . . . . .	2
Antennas . . . . .	2
Base . . . . .	3
Keyboard . . . . .	3
Touchpad . . . . .	4
Left . . . . .	5
Multi-purpose USB Type-C connector . . . . .	5
Charging light . . . . .	5
USB Standard-A connector . . . . .	6
Always-on connector . . . . .	6
HDMI connector . . . . .	6
Combo audio jack . . . . .	6
Speakers . . . . .	6
Right . . . . .	7
Speakers . . . . .	7
Power light . . . . .	7
Power button . . . . .	8
Fingerprint sensor . . . . .	8
microSD card slot . . . . .	8
USB Standard-A connector . . . . .	8
Security lock slot . . . . .	8
Bottom . . . . .	9
Avoid constant body contact with specific hot sections . . . . .	9
Air vents (intake) . . . . .	9
Novo button hole . . . . .	9
Rear . . . . .	11
Air vents (outlet) . . . . .	11
Features and specifications . . . . .	12
Statement on USB transfer rate . . . . .	14
Operating environment . . . . .	14

## Chapter 2. Get started with your computer . . . . . 15

Connect to a network . . . . .	15
Connect to a Wi-Fi network . . . . .	15
Establish a wired connection . . . . .	15
Unique Lenovo apps . . . . .	16

Lenovo Vantage . . . . .	16
Lenovo Smart Meeting . . . . .	16
Work with Windows . . . . .	18
Windows help information . . . . .	19
The Novo Button menu . . . . .	19
Open the Novo Button menu . . . . .	19
Interact with your computer . . . . .	19
Hotkeys . . . . .	19
The Copilot key . . . . .	21
Touch operations supported by Windows . . . . .	21
Connect to an external display . . . . .	23
Protect your privacy using the camera shutter . . . . .	24
Enroll your fingerprints . . . . .	24
Yoga modes . . . . .	24
Lenovo Slim Pen (for selected models) . . . . .	26

## Chapter 3. Explore your computer . . . . . 29

Intelligent features . . . . .	29
Gesture controls . . . . .	29
Smart Key . . . . .	29
Smart Noise Cancelling . . . . .	30
Super Resolution . . . . .	31
Eye Care Mode . . . . .	31
Manage power . . . . .	31
Rechargeable battery pack . . . . .	31
Set power button behavior . . . . .	32
A power plan . . . . .	33
System operation modes . . . . .	33
Change settings in UEFI/BIOS setup utility . . . . .	34
What is UEFI/BIOS setup utility . . . . .	34
Open the UEFI/BIOS setup utility . . . . .	34
Select boot devices . . . . .	34
Change hotkey mode . . . . .	34
Enable or disable always-on . . . . .	34
Set passwords in UEFI/BIOS setup utility . . . . .	34
Password types . . . . .	35
Set administrator password . . . . .	35
Change or remove administrator password . . . . .	35
Set user password . . . . .	36
Enable power-on password . . . . .	36
Set hard disk password . . . . .	36
Change or remove hard disk password . . . . .	36

## Chapter 4. Help and support . . . . . 39

Frequently asked questions . . . . .	39
How do I partition my storage drive . . . . .	39

What should I do if my computer stops responding . . . . .	39
What should I do if I spill liquid on the computer . . . . .	39
Where can I get the latest device drivers and UEFI/BIOS . . . . .	39
Why does my computer start automatically when I open the lid . . . . .	39
I pressed the Copilot key on my keyboard, but neither Copilot in Windows nor Windows Search opened. What could be the potential cause? . . . . .	39
Self-help resources . . . . .	40

What is a CRU? . . . . .	41
CRUs for your product model . . . . .	41
Call Lenovo . . . . .	43
Before you contact Lenovo . . . . .	43
Lenovo Customer Support Center . . . . .	43
Purchase additional services. . . . .	44

**Appendix A. Function descriptions for Lenovo hotkeys . . . . . 45**

**Appendix B. Notices and trademarks. . . . . 47**

---

## About this guide

- This guide applies to Lenovo product model(s) listed below. Illustrations in this guide may look slightly different from your product model.

Model name	Machine type (MT)
ThinkBook 14 2-in-1 G4 IML	21MX
ThinkBook 14 2-in-1 G4 IML 1	21MX
ThinkBook 14 2-in-1 G4 IML 2	21MX

- For further compliance information, refer to the *Generic Safety and Compliance Notices* at [https://pcsupport.lenovo.com/docs/generic\\_notices](https://pcsupport.lenovo.com/docs/generic_notices).
- This guide may contain information about accessories, features, and software that are not available on all models.
- This guide contains instructions that are based on the Windows operating system. These instructions are not applicable if you install and use other operating systems.
- Microsoft® makes periodic feature changes to the Windows® operating system through Windows Update. As a result, the operating system related instructions may become outdated. Refer to Microsoft resources for the latest information.
- The content of the guide is subject to change without notice. To obtain the latest version, go to <https://support.lenovo.com>.



---

## Chapter 1. Meet your computer

---

### Front

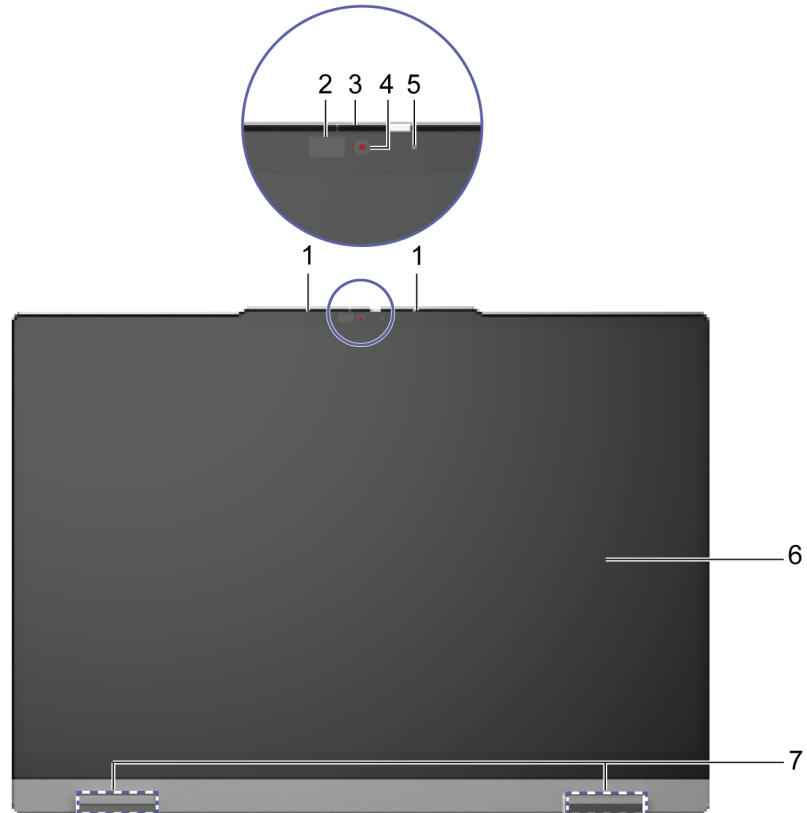

No.	Description
1	Microphones
2	Infrared LED*
3	Camera shutter
4	Camera
5	Camera light
6	Screen
7	Antennas

\* for selected models

### Microphones

The microphones are the PC's built-in sound input devices. They capture your voice and ambient sound and convert them into digital form. Microphones are essential components when you use your PC for video conferencing or voice recording.

## Infrared LED

The infrared LED generates and emits near-infrared waves that are received and used by a camera (or a dedicated infrared camera) for facial recognition.

## Camera shutter

The camera shutter is a sliding cap that you can move to block the camera lens.

**Note:** The camera shutter is designed for privacy protection. When the camera lens is blocked, the camera function is disabled.

## Camera

The built-in camera captures visible light and converts it to digital signals. It is used for video recording and video conferencing.

The camera for some models can also detect near-infrared waves. For those models, an IR LED is also included to emit near-infrared waves. They are used together to achieve face-based authentication.

## Camera light

The camera light indicates whether the camera is activated.

*Table 1. Camera light status and description*

Camera light status	Description
On	The camera is activated.
Off	The camera is not activated.

## Screen

The screen of the built-in display is where text, graphics, and videos are displayed.

The screen is touch-enabled, allowing you to interact with your PC by intuitively touching buttons, icons, and menu items displayed on the screen. Touch-enabled screens also support multi-finger gestures.

## Antennas

The antennas transmit and receive radio waves to allow data to be transferred between your PC and a Wi-Fi network device or a Bluetooth device.

**Note:** The antennas are hidden inside the PC.



## Base



No.	Description
1	Keyboard
2	Touchpad

## Keyboard

The keyboard is the PC's built-in input device for typing characters. It also includes keys that can make you more productive when interacting with the PC, apps, and the Windows operating system.

Table 2. Productivity keys

Key	Location on the keyboard	Function
Function keys (F1 through F12)	In the top row	Executing predefined commands or functions for selected apps
Hotkeys	In the top row	<ul style="list-style-type: none"><li>Changing some of the PC's frequently used settings</li><li>Opening an app or a Windows gadget</li></ul>
Fn key	In the lower-left corner	<ul style="list-style-type: none"><li>Toggling the functions of dual-function keys</li><li>Used with several letter keys to change some of the PC's frequently used settings</li></ul>
Windows key	In the lower-left corner	Used with certain keys to change some frequently used Windows settings

Hotkeys share keys with function keys. To toggle the functions for these keys, hold down the Fn key or turn on the FnLock switch.

**Note:** Keyboard layout varies by language and geographical location. The keyboard on your PC may look slightly different from the product illustrations of this publication.

## **Touchpad**

The touchpad is the PC's built-in pointing device, which provides the basic functionality of an external mouse. Slide your finger on the touchpad to move the pointer on the screen and tap or double-tap to select or execute a screen item.

The touchpad also supports Windows multi-finger gestures, which provide shortcuts to frequently used apps and functions.

## Left

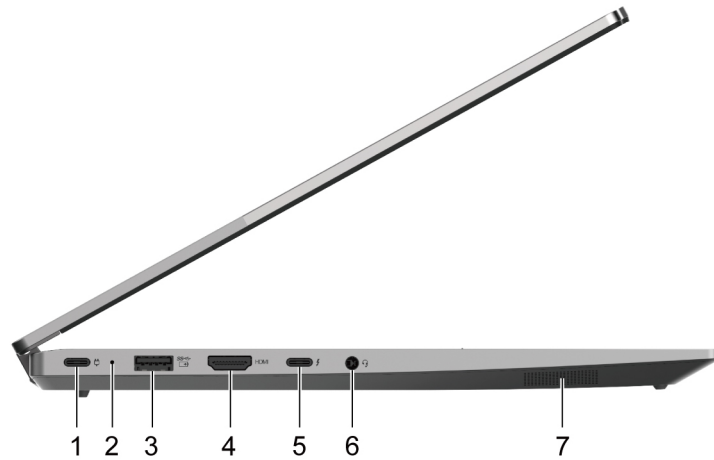

No.	Description
1, 5	Multi-purpose USB Type-C® connector
2	Charging light
3	USB Standard-A connector (always-on)
4	HDMI™ connector
6	Combo audio jack
7	Speaker

### Multi-purpose USB Type-C connector

This USB Type-C® connector is the PC's power input connector. Use the included power adapter and this connector to supply power to the PC.

When this connector is not used by the included power adapter, it can also be used to connect:

- Storage or peripheral devices that follow the universal serial bus (USB) specification for data transfer and device interconnection
- Display devices

**Note:** When connecting display devices, you need to use appropriate cables and adapters (if needed) according to the connection capabilities of the display device.

- Thunderbolt™-enabled docks or devices (for the connector with an icon ⚡ next to it)

### Charging light

The charging light indicates whether the PC is plugged into an electrical outlet. When the PC is plugged into an electrical outlet, the color of the light indicates whether the battery is fully charged (or will shortly be fully charged).

Table 3. Charging light statuses and descriptions

Light status	Plugged in?	Battery charge level
Off	No	/
On, amber	Yes	1%–90%
On, white	Yes	91%–100%

## USB Standard-A connector

The USB Standard-A connector is used to connect storage or peripheral devices that follow the universal serial bus (USB) specification for data transfer and device interconnection.

## Always-on connector

A USB connector with a battery icon (🔋) supports the always-on function. The PC can supply power to a USB device connected to this type of connector even when the PC is powered off, in sleep mode, or in hibernation mode.

The always-on function can be turned on and off in:

- The PC's firmware setup utility, or
- Lenovo Vantage or Lenovo PC Manager

## HDMI connector

The HDMI connector is used to connect an external display device, such as a television, a projector, or a monitor.

## Combo audio jack

The combo audio jack is used to connect single-plug headsets, headphones, or external speakers.

## Speakers

The speakers are the PC's built-in sound output devices.

## Right

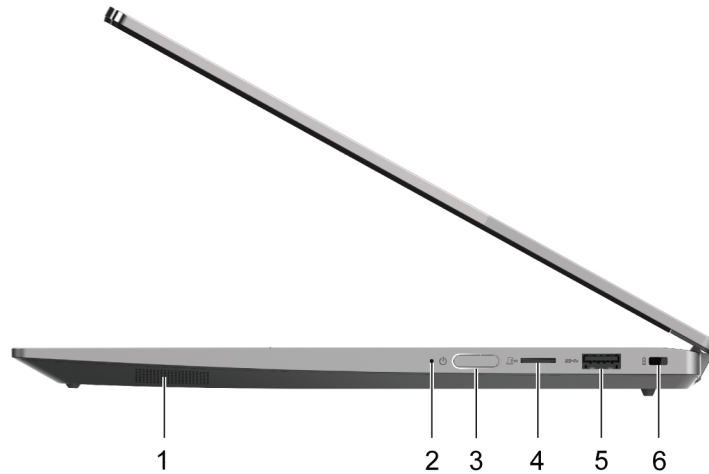

No.	Description
1	Speaker
2	Power light
3	Power button (with an embedded fingerprint sensor)
4	microSD™ card slot
5	USB Standard-A connector
6	Security lock slot

## Speakers

The speakers are the PC's built-in sound output devices.

## Power light

The power light indicates the current power state of the PC: whether it is powered on, powered off, in sleep mode, or in hibernation mode.

When the PC is powered on, this light can also indicate low battery by blinking rapidly.

Table 4. Power light status and description

Light status	Power state	Battery charge level
White (solid on)	Powered on	21%–100%
Amber (solid on)	Powered on	1%–20%
White (blinking slowly)	In sleep mode	/
Off	Powered off or in hibernation mode	/

If the PC's power button includes an embedded fingerprint sensor, the power light turns solid green to prompt you to enroll or scan your fingerprint.

## Power button

Press the power button to turn on your PC.

**Note:** By default, on a Windows PC, pressing the power button when the PC is turned on will put the PC into sleep mode.

## Fingerprint sensor

The fingerprint sensor scans your finger to unlock your PC or verify your identity.

**Note:** You need to enroll one or more fingerprints before using them for identity verification. On a Windows PC, go to **Settings** → **Accounts** → **Sign-in options** to enroll your fingerprints.

## microSD card slot

The microSD card slot is used to insert a microSD, microSDHC, or microSDXC memory card to transfer data between the memory card and your PC.

## USB Standard-A connector

The USB Standard-A connector is used to connect storage or peripheral devices that follow the universal serial bus (USB) specification for data transfer and device interconnection.

## Security lock slot

The security lock slot is used to attach a compatible cable lock. The cable lock typically includes a loop at one end and can be used to secure the PC to a stationary object, preventing theft when the PC is left unattended for a short period of time in cafes, shops, libraries, and other public places.

## Bottom

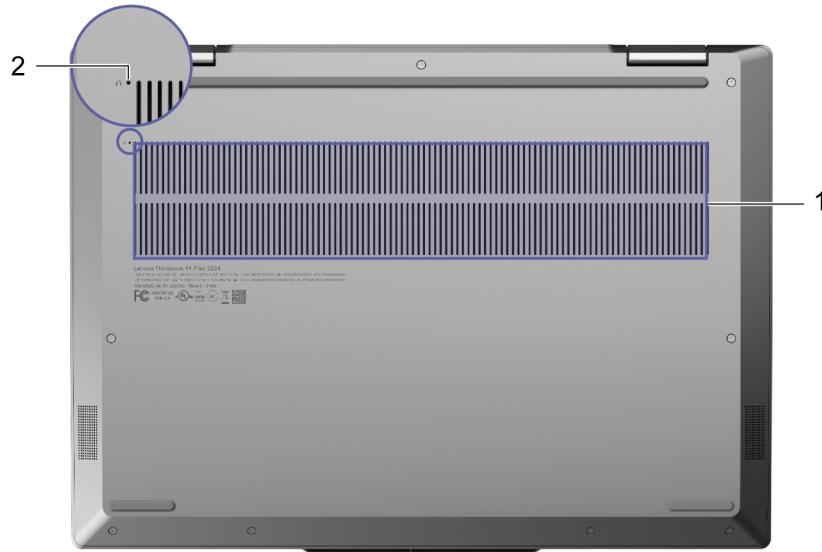

No.	Description
1	Air vents (intake)
2	Novo button hole

## Avoid constant body contact with specific hot sections

### CAUTION:

When the computer is operating, it should be placed on a hard and flat surface with its bottom area not in contact with user's bare skin. Under normal operating conditions, the temperature of the bottom surface will remain within an acceptable range as defined in *IEC 62368-1*, but such temperatures can still be high enough to cause discomfort or harm to the user if directly touched for over one minute at a time. As such, it is recommended that users avoid prolonged direct contact with the bottom of the computer.

## Air vents (intake)

The air vents allow air to be sucked inside of the PC to cool the internal components.

**Important:** When the PC is operating, do not place it on a bed, sofa, carpet, or other flexible surfaces. Otherwise, the air vents will be blocked and the PC may overheat, reducing performance or causing the PC to be unresponsive or even shut down.

## Novo button hole

When the PC is powered off, you can press the Novo button to display the Novo button menu. From the menu, you can then choose to:

- Open the firmware setup utility
- Display the boot device selection menu
- Display the Windows advanced startup options page

**Note:** The Novo button is rarely used during normal PC operations. To prevent users from accidentally pressing it, the Novo button is placed in a recessed hole. You can use a straightened paper clip to press this button.



---

## Rear



No.	Description
1	Air vents (outlet)

### Air vents (outlet)

The air vents allow hot air to be discharged out of the PC.

**Important:** When the PC is operating, do not place it on a bed, sofa, carpet, or other flexible surfaces. Otherwise, the air vents will be blocked and the PC may overheat, reducing performance or causing the PC to be unresponsive or even shut down.

---

## Features and specifications

### Dimensions

Width	313 mm
Depth	224 mm
Thickness	<ul style="list-style-type: none"><li>• Thinnest: 16.9 mm</li><li>• Thickest: 18.5 mm</li></ul>

### ac power adapter

Input	100 V ac–240 V ac, 50 Hz–60 Hz
Output	20 V dc, 3.25 A
Power	65 W

### Rechargeable battery pack

Capacity	60 Wh
Cell type	Lithium-polymer
Number of cells	4

**Note:** The battery capacity is the typical or average capacity as measured in a specific test environment. Capacities measured in other environments may differ but are no lower than the rated capacity (see product label).

### Memory

Type	DDR5
Installation	Slot mounted
Number of slots	2

### Mass storage device

Type	Solid-state drive (SSD)
Slot type	<ul style="list-style-type: none"><li>• M.2 (2242), or</li><li>• M.2 (2280)</li></ul>
Interface	PCIe Gen 4

### Display

Screen size (diagonal)	14 inches
Resolution	1920 × 1200 pixels
Refresh rate	60 Hz

## Connectors and slots

USB Standard-A connector	<ul style="list-style-type: none"><li>• Quantity: 2</li><li>• Maximum power output: 5 V, 0.9 A</li><li>• Supported signaling protocols:<ul style="list-style-type: none"><li>– USB 2.0 480 Mbps</li><li>– SuperSpeed USB 5 Gbps</li></ul></li></ul> <p><b>Note:</b> The always-on connector supports maximum power output of 5 V and 2 A.</p>
Multi-purpose USB Type-C connector	<ul style="list-style-type: none"><li>• Quantity: 2</li><li>• Maximum power output: 15 W (5 V, 3 A)</li><li>• Maximum power input: 65 W</li><li>• Supported signaling protocols:<ul style="list-style-type: none"><li>– USB 2.0 480 Mbps</li><li>– SuperSpeed USB 5 Gbps</li><li>– SuperSpeed USB 10 Gbps</li><li>– DisplayPort™ 1.4</li><li>– Thunderbolt 4 41.25 Gbps (for the connector with an icon ⚡ next to it)</li></ul></li></ul>
HDMI connector	Supported signaling protocol: Transition minimized differential signaling (TMDS)
Combo audio jack	<ul style="list-style-type: none"><li>• Diameter: 3.5 mm</li><li>• Supported plugs:<ul style="list-style-type: none"><li>– 3-pole, TRS</li><li>– 4-pole, TRRS (CTIA and OMTP)</li></ul></li></ul>
microSD slot	Supported card types: <ul style="list-style-type: none"><li>• microSD™</li><li>• microSD High Capacity (microSDHC™)</li><li>• microSD Extended Capacity (microSDXC™)</li></ul>
Security lock slot	Kensington Nano Security Slot™

**Note:** Data rates and performance ratings are dependent on connected devices and cables if they are used. USB Type-C connectors that are DisplayPort 1.4 compliant through DisplayPort alternate mode provide a maximum output resolution of 5120 x 3200, at a 60 Hz frame rate and color depth of 24 bpp (bits per pixel). The actual maximum output resolution is dependent on the connected display device and the cable being used.

## Networking

Wi-Fi®	<ul style="list-style-type: none"><li>• Wi-Fi 6, or</li><li>• Wi-Fi 6E</li></ul>
Bluetooth	<ul style="list-style-type: none"><li>• Wi-Fi 6: Bluetooth 5.2</li><li>• Wi-Fi 6E: Bluetooth 5.3</li></ul>

## Statement on USB transfer rate

Depending on many factors such as the processing capability of the host and peripheral devices, file attributes, and other factors related to system configuration and operating environments, the actual transfer rate using the various USB connectors on this device will vary and will be slower than the data rate listed below for each corresponding device.

USB device	Data rate (Gbit/s)
USB 3.2 Gen 1	5
USB 3.2 Gen 2	10

## Operating environment

### Maximum altitude (without pressurization)

3048 m (10 000 ft)

### Temperature

- At altitudes up to 2438 m (8000 ft)
  - Operating: 5°C to 35°C (41°F to 95°F)
  - Storage: 5°C to 43°C (41°F to 109°F)
- At altitudes above 2438 m (8000 ft)
  - Maximum temperature when operating under the unpressurized condition: 31.3°C (88°F)

**Note:** When you charge the battery, its temperature must be no lower than 10°C (50°F).

### Relative humidity

- Operating: 8% to 95% at wet-bulb temperature 23°C (73°F)
- Storage: 5% to 95% at wet-bulb temperature 27°C (81°F)

---

## Chapter 2. Get started with your computer

---

### Connect to a network

#### Connect to a Wi-Fi network

Ensure that you have a secure Wi-Fi network account and the required credentials.

- Step 1. Select the network icon  on the bottom right of your display.
- Step 2. Select an available network, and then select **Connect**. If you want to be automatically connected to this Wi-Fi network the next time you start your computer, select **Connect automatically** before selecting **Connect**.
- Step 3. Input your credentials if necessary, and then follow the on-screen instructions to connect to the desired Wi-Fi network.

#### Establish a wired connection

- Step 1. Plug an Ethernet cable into the Ethernet connector on your computer.
- Step 2. Plug the other end of the Ethernet cable into a network wall jack or a router.

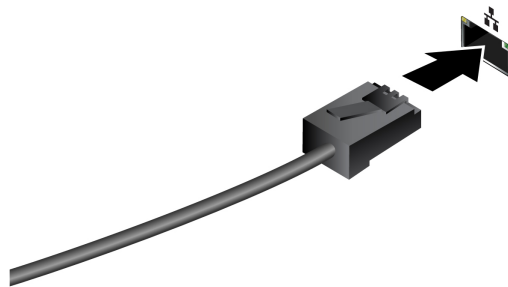

**Note:** If your computer does not include an Ethernet connector, you can purchase a USB-C to Ethernet adapter from Lenovo at <https://www.lenovo.com/accessories>.

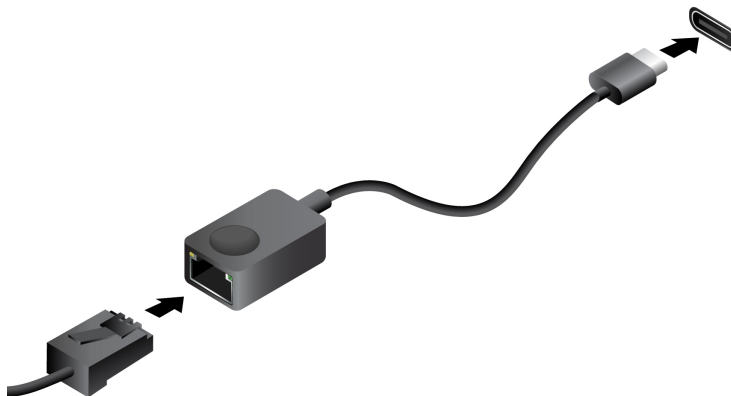

---

## Unique Lenovo apps

### Lenovo Vantage

Lenovo Vantage is a one-stop solution to help you update your computer, configure hardware settings, and access personalized support.

If your computer is pre-installed with Lenovo Vantage, type `Vantage` in the Windows search box to launch this app.

#### Notes:

- Available features may vary depending on your computer model.
- You can download the latest version of this app from Microsoft Store.

### Lenovo Smart Meeting

Lenovo Smart Meeting is a video conferencing app with multiple features for enhancing your professional image, protecting your privacy, and reducing your computer's power consumption.

If you want your settings in this app to also take effect on other mainstream video conferencing apps, such as Microsoft Teams and Zoom, ensure that you select Lenovo Virtual Camera in the app.

#### Access the app

Type `Lenovo Smart Meeting` in the Windows search box and then press `Enter`.

#### Explore key features

- **Smart appearance**
  - **Video enhancer:** Adjust the brightness automatically for better image quality during the video call.



- **Face framing:** Keep your face centered automatically during the video call when you move around.

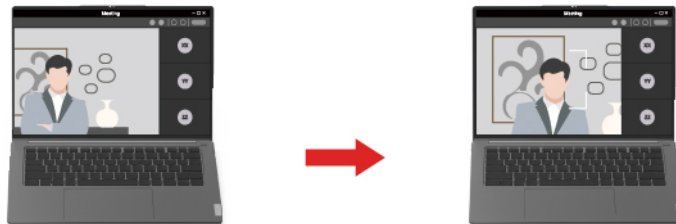

- **Customized background:** Blur or customize your background during the video call to protect your privacy.



- **Temporary Avatar:** Create and display a temporary portrait of you as if you were still in the video conference when you are temporarily away.



- **Intelligent sensing**
  - **Presence detection:** Keep your computer awake when you are facing the screen and lock the computer screen automatically when you leave. You can customize the screen-off time from 10 to 60 seconds.



- **Privacy protection:** Blur your screen and display a warning message when a shoulder surfer is detected.



- **Adaptive dimming:** Track your face movements to recognize your focus of attention. When you are facing away, the display dims to conserve power. You can customize the brightness value and screen dimming timer.

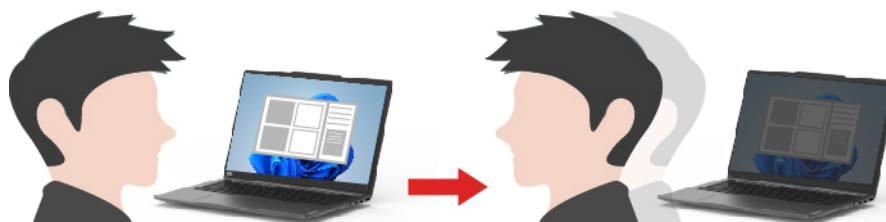

## Notes:

- Lenovo does not collect any personal data from this app.
- The available features vary depending on the computer model.
- Lenovo Smart Meeting makes periodic feature updates to keep improving your experience. The description described here might be different from that on your actual user interface.

---

## Work with Windows

The following table contains Windows frequently used settings. You can learn the basics and start working with Windows right away.

To configure settings, type the corresponding keywords in the Windows search box and select the best match. Follow the on-screen instructions to customize settings.

Table 5. Basic settings

Functions	Descriptions	Search by keywords
Control Panel	View or change Windows settings, including hardware and software setup and configuration.	Control Panel
Connect to Wi-Fi networks	For models with a wireless LAN module, you can connect your computer to a Wi-Fi network. Click the network icon in the Windows notification area, and then select a network for connection. <b>Note:</b> The wireless LAN module on your computer may support different standards. For some countries or regions, use of 802.11ax may be disabled according to local regulations.	Wi-Fi
Airplane mode	Airplane mode is a convenient setting to turn all wireless communications of your computer on and off. You may need to turn it on when boarding an airplane.	Airplane mode
Night light mode	Night light is a switch in Windows that you can turn on and off. When it is turned on, your screen shows warmer colors and the amount of emitted blue light is reduced. Enabling night light reduces the chances of developing eye fatigue or eye strain. <b>Note:</b> For more guidance on reducing eye fatigue or eye strain, go to <a href="https://www.lenovo.com/us/en/compliance/visual-fatigue">https://www.lenovo.com/us/en/compliance/visual-fatigue</a> .	Night light
Adjust color temperature	If night light mode is turned on, you can adjust the color temperature of the screen. <b>Note:</b> Selected Lenovo computers are low blue light certified using night light mode and color temperature settings available in the pre-installed operating system. These computers are tested with night light turned on and color temperature set to 48 or greater.	Night light
Windows Updates	Microsoft periodically releases feature and security updates to the Windows operating system. Updates that are applicable to your Windows version are downloaded automatically when your computer is connected to the Internet. When updates are downloaded, you are prompted to restart the computer to install these updates. You can also manually check if there are available updates for the installed version of Windows. <b>Attention:</b> Only use Windows Update to download and install updates. Updates downloaded from other sources may include security risks.	Windows Updates



Table 6. Optional settings

Functions	Descriptions	Search by keywords
Set up face recognition*	For models with a Windows Hello-compatible infrared camera, you can set up face recognition to sign in with your face.	Sign-in options
Enroll your fingerprint	For models with a fingerprint sensor, you can enroll your fingerprint for Windows sign-in.	Sign-in options

\* for selected models

## Windows help information

If the on-screen instructions cannot solve your problem, refer to the following to get the online Windows help information.

- Type Get Help or Tips in the Windows search box and then press Enter. When the app opens, type the problem description and select the matched result.
- Visit Microsoft support Web site: <https://support.microsoft.com>. Enter what you are looking for in the search box and get search results.

---

## The Novo Button menu

The Novo Button menu can be displayed before the operating system starts. From the menu, you can choose to

- Open the BIOS/UEFI setup utility
- Open the boot device selection menu
- Open the Windows startup options screen

**Note:** From the Windows startup options screen, you can then choose to

- Start your computer using a recovery drive
- Reset your computer
- Open advanced options screen

## Open the Novo Button menu

For Lenovo computers with a Novo button, you can press the button to open the Novo Button menu.

Step 1. Turn off the computer.

Step 2. Open the LCD screen and press the Novo button.

**Note:** Alternatively, turn off the computer. Press Fn and the power button to open the Novo Button menu.

---

## Interact with your computer

### Hotkeys

Look at the top row of the keyboard of your Lenovo computer and you'll find keys with printed icons. These keys are called hotkeys and they provide shortcuts to functions that you'll use frequently. The function that each hotkey provides is denoted by the icon printed on the key.

Hotkeys share keys with function keys (F1–F12) and other keys. Depending on the FnLock setting, you use hotkey functions by pressing the key directly or in combination with the Fn key.

**Note:** The FnLock switch does not apply to hotkeys not found in the first row of the keyboard. To use these hotkeys, always hold down the Fn key while pressing the key.

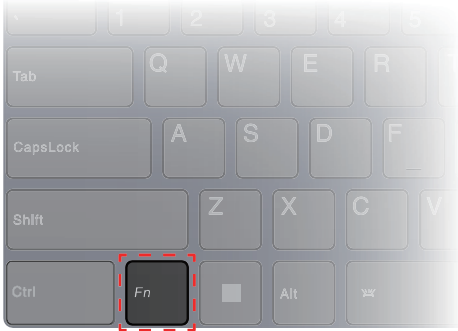

Figure 1. Location of the Fn key

### Related topics

Appendix A “Function descriptions for Lenovo hotkeys” on page 45

### The FnLock switch

The FnLock is an electronic switch that affects how you use hotkey functions. To turn it on and off, press Fn + Esc.

**Note:** The Esc key is in the upper left corner of the keyboard. It has an LED that indicates the status of the FnLock switch.

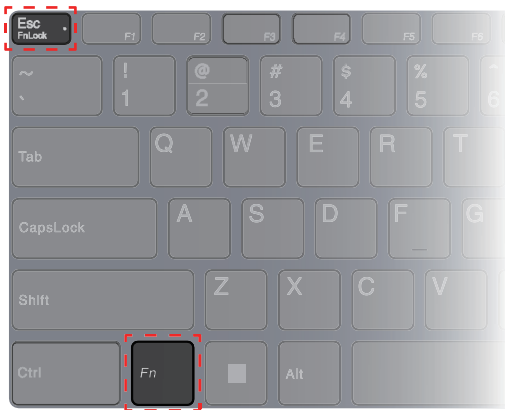

Figure 2. Locations of the FnLock key and the Fn key

A Lenovo keyboard usually contains hotkeys in the top row. These hotkeys share keys with the function keys (F1–F12) and other keys. For these dual-function keys, the icons or characters denoting the primary functions are printed on top of the icons and characters denoting the secondary functions.

- A: an icon or character denoting the primary function
- B: an icon or character denoting the secondary function

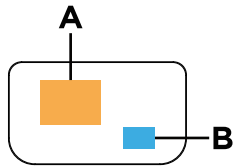



Figure 3. The layout of a dual-function key

Table 7. **FnLock** and dual-function keys

FnLock (Esc) LED	FnLock status	Pressing the hotkey alone	Pressing the hotkey while holding down the Fn key
Off	Disabled	Primary function	Secondary function
On	Enabled	Secondary function	Primary function

## The Copilot key

The era of AI has arrived, and many Lenovo PCs now include a Copilot key on the keyboard. It is located either in the bottom or the top row of the keyboard and is marked with .

For Windows PCs with Copilot in Windows available and enabled, pressing the Copilot key opens Copilot in Windows. Otherwise, pressing the Copilot key opens Windows Search.

**Note:** Copilot in Windows may not be available in all geographical locations. In regions where Copilot in Windows is available, you may need to update your Windows operating system to version 23H2 or later through Windows Update for Copilot in Windows to become available.

### Related topics

“I pressed the Copilot key on my keyboard, but neither Copilot in Windows nor Windows Search opened. What could be the potential cause?” on page 39

## Touch operations supported by Windows

For computers with a touch-enabled screen, you can touch the screen directly with your fingers and interact with your computer in a more natural way. The following table lists frequently used touch operations that are supported by the Windows operating system.

**Touch operation**

**Used for**



Tap

Opening apps, documents, and other functions on the taskbar or the Start menu



Tap twice quickly

Opening apps that are pinned on the desktop



Tap, hold and lift

Opening the context menu

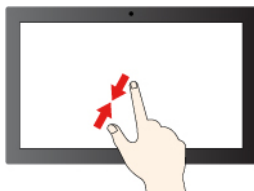

Pinch

Zooming out

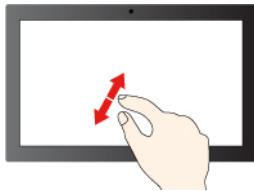

Spread

Zooming in

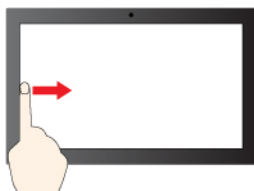

Swipe in from the left edge

Opening the widgets panel

### Touch operation

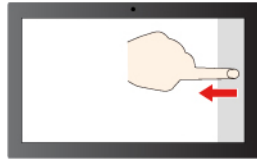

Swipe in from the right edge

### Used for

Opening the notification center

The Windows operating system also supports 3- and 4-finger gestures on the screen and the touchpad. You can set them up in **Settings** → **Bluetooth & devices**.

## Connect to an external display

### Connect to a wired display

Connect your computer to the desired display with an appropriate cable.

- Step 1. Connect one end of the display cable to the HDMI connector or a multi-purpose USB Type-C connector on your computer.
- Step 2. Connect the other end of the cable to the display.

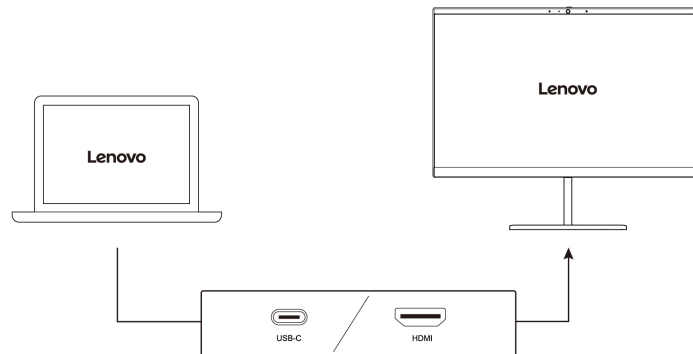

### Connect to a wireless display

Ensure that:

- Both your computer and the display support Miracast® technology.
- The display is connected to the same Wi-Fi network as your computer and is discoverable.

- Step 1. Press Windows key + K.  
The computer searches for wireless display devices and audio devices and lists the results.
- Step 2. Select the display you want to connect to, and then follow the on-screen instructions.

### Change display settings

- Step 1. Right-click on a blank area on the desktop, and then select **Display settings**.  
Your computer shows the **Display** window.
- Step 2. Select the display for which you want to change the settings.

Step 3. Change the display settings as necessary.

## Set the display mode

Step 1. Press  or Fn + .

Your computer shows a list of display modes, with the current mode highlighted.

Step 2. Select a display mode from the list.

## Protect your privacy using the camera shutter

The camera shutter is a mechanical component that prevents any attempt from capturing your image, thus protecting your privacy. To cover the camera lens, slide the camera shutter to the left. When you want to use the camera, slide the camera shutter to the right.

If you slide the camera shutter to the left during a video call, people on the video call will not be able to see you. If you slide the camera shutter back to the right, they will be able to see you again.

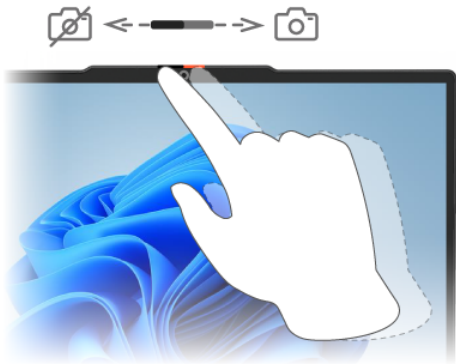

## Enroll your fingerprints

You can use the biometric fingerprint option to sign in to Windows quickly if your computer includes a fingerprint sensor. This sign-in option provides a reliable and secure way of identity verification.

Step 1. Select **Start** → **Settings** → **Accounts** → **Sign-in options**.

Step 2. Under **Ways to sign in**, select **Fingerprint recognition (Windows Hello)** to set up sign-in with a fingerprint sensor.

Step 3. Follow the on-screen instructions to enroll your fingerprints.

### Notes:

- You need to set up a PIN code before you are allowed to use this sign-in option.
- It is recommended that you enroll multiple fingerprints in case of any injuries to your fingers.

## Yoga modes

The screen of your computer can open up to an angle of 360 degrees, enabling you to use your computer for different purposes.

---

**Mode**

Notebook mode

**Suitable for**

- Entering text
- Drag and drop operations using the touchpad

Stand mode

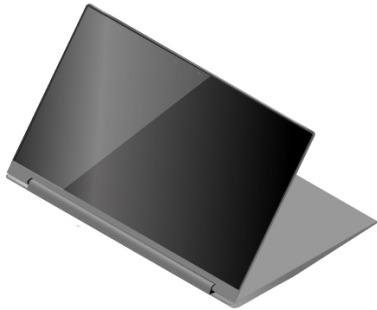

- Giving a presentation
- Viewing a slide show

---

**Mode**

Tent mode

**Suitable for**

Watching movies

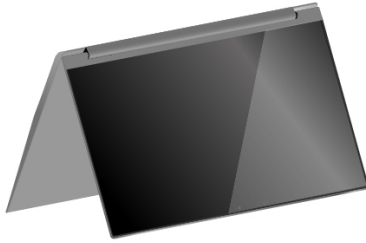

Tablet mode

Playing touch-enabled games



---

**Note:** Product illustrations in this section are used to demonstrate features that are supported by a range of Lenovo products. It is normal that they may look different from your product model.

## Lenovo Slim Pen (for selected models)

The Lenovo Slim Pen is referred to as the pen in this section.

Depending on the model, your computer might come with a pen. The pen enables you to write and draw in a natural manner.

**Notes:**

- The pen is not waterproof. Take care not to drop the pen in water.
- The pen contains pressure sensors. Do not push the tip of the pen for an extended period of time. Do not subject the pen to shock or vibration.

**Before first use**

Charge the pen before first use.



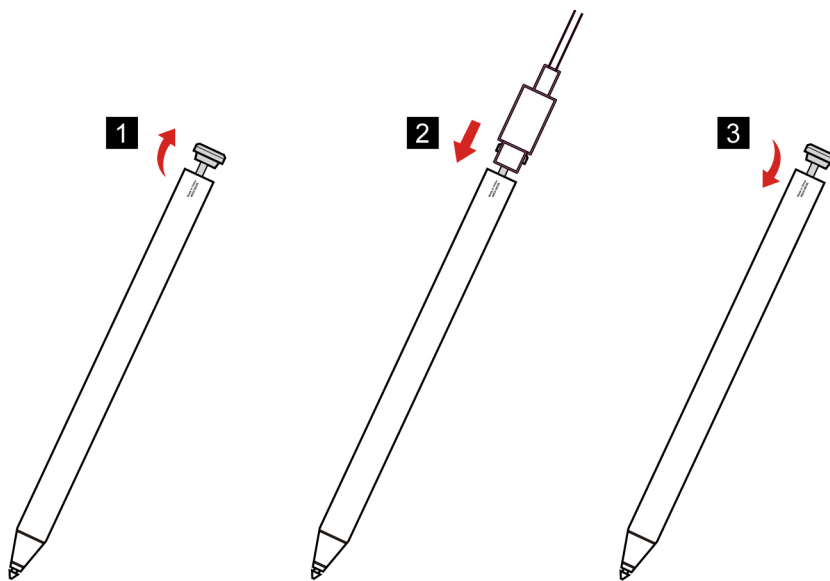

- Step 1. Open the pen cap.
- Step 2. Connect the pen to a charger with a USB Type-C cable.
- Step 3. Disconnect the charger cable. Place the pen cap back.

**Notes:**

- Please pull out the pen cap gently. Strong force may cause the dust-proofing pen cap to break off.
- You can check the pen's battery level in the Lenovo Pen Settings.

**Use the pen**

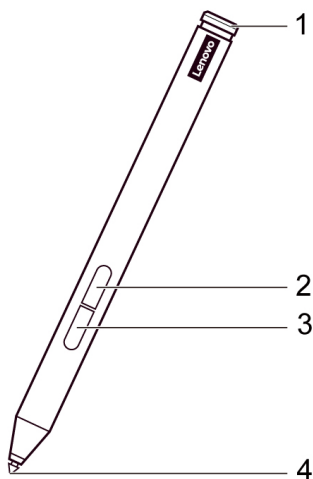

Figure 4. Lenovo Slim Pen

Item	Component	Description
1	Pen cap	Open the pen cap to charge the pen.
2	Top button	To right-click, press and hold the top button and tap the screen in supported applications.

Item	Component	Description
3	Bottom button	To erase text or drawings, press and hold the bottom button and rub at the targeted items with the pen tip in supported applications.
4	Pen tip	Write or draw on the touch screen.

**Notes:**

- The default function of each button may vary in different applications.
- You can view or change the functions in the Lenovo Pen Settings.

**Store the pen**

When the pen is not in use, attach it to the lower right side of your computer.

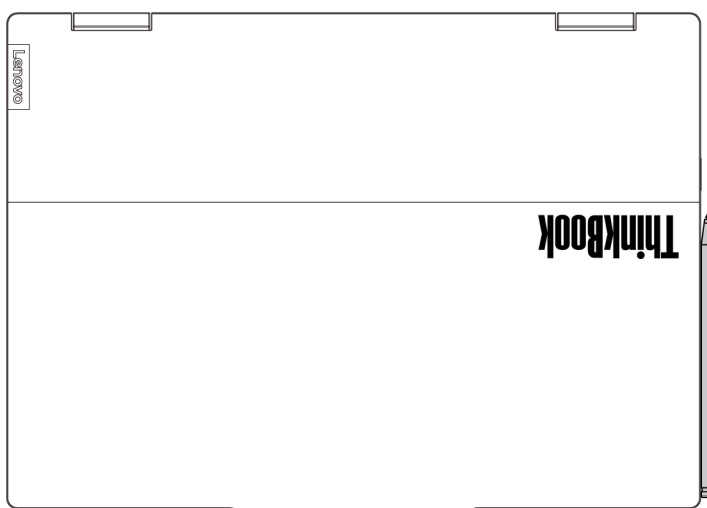

**Lenovo Pen Settings**

Lenovo Pen Settings is a pre-installed app for setting up Lenovo digital pens. This app allows you to perform the following functions:

- Reassign pen button functions
- Adjust pen sensitivity
- Check the pen's battery level

To open the Lenovo Pen Settings, type the app name in the Windows search box and select the matched result. If the software is not pre-installed, you can download and install the latest drivers from <https://support.lenovo.com>.

---

## Chapter 3. Explore your computer

---

### Intelligent features

Your computer may be pre-installed with either Lenovo Vantage or Lenovo PC Manager. Most features described here can be enabled or disabled in one of these apps. Other features may be enabled in a standalone app.

#### Notes:

- Software features are subject to change. Please refer to your actual product.
- You may need to complete online update to the apps for the features to take effect.

### Gesture controls

#### Lenovo unique touch gestures

In addition to touch gestures supported by the Windows operating system, some Lenovo computers may support additional touch gestures. You can perform these gestures on the touchpad of your computer.

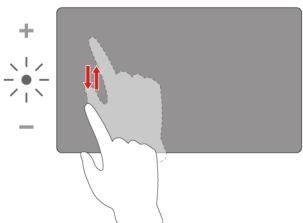
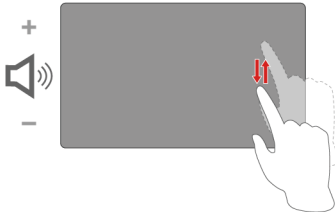
Gesture	Function
 <p>Slide up/down on the left side of the touchpad <b>Note:</b> For computers with a touch-enabled screen, you can also perform this gesture on the left side of the screen.</p>	Increases/Decreases display brightness when you watch videos in full screen mode. <b>Note:</b> This gesture is not supported by all video players and may conflict with similar third-party gesture functions.
 <p>Slide up/down on the right side of the touchpad <b>Note:</b> For computers with a touch-enabled screen, you can also perform this gesture on the right side of the screen.</p>	Increases/Decreases system volume when you watch videos in full screen mode. <b>Note:</b> This gesture is not supported by all video players and may conflict with similar third-party gesture functions.

### Smart Key

Smart Key  provides a quick shortcut to Lenovo apps and service. Press Smart Key to open the launch panel.

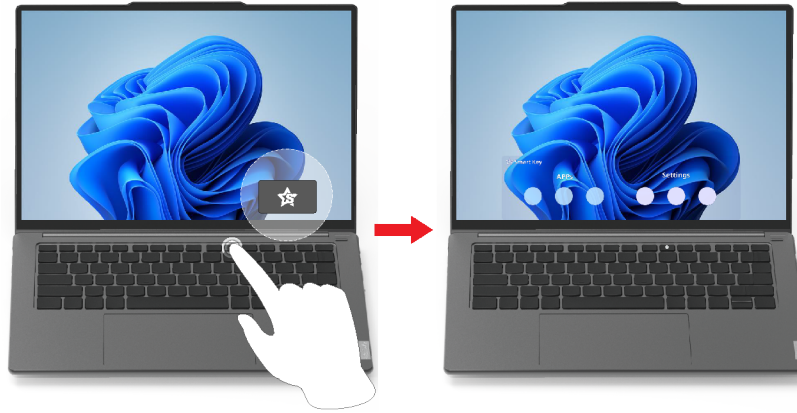

**Note:** There is also a trick to Smart Key. Go to **Preference** on the launch panel, select **ADD** and choose your favorite app to associate with Smart Key. When it is done, press Smart Key twice in quick succession and your favorite app is opened.

### Smart Noise Cancelling

Smart Noise Cancelling is a noise reduction feature available on some Lenovo product models. By filtering out input and output noises, Smart Noise Cancelling enhances your audio experience.



Function	Description	Remarks
Microphone noise cancelling	<b>Voice Recognition:</b> Your computer captures multiple voices in a way that reflects their original spatial positions.	<ul style="list-style-type: none"> <li>This function takes effect only when built-in microphones/arrays or 3.5 mm jack wired microphones are used as the input media.</li> <li>To disable this function, select <b>Off</b>.</li> </ul>
	<b>Only My Voice:</b> This option requires you to record your voice so that your computer captures this voice only and tries to eliminate other voices. <b>Note:</b> To remove your voice record, select <b>REMOVE MY VOICE</b> .	
	<b>Normal:</b> Your computer focuses on the voice of the person facing it and reduces ambient sounds.	
	<b>Multiple Voices:</b> Your computer captures multiple voices from an expanded range in front of the computer.	
Speaker noise cancelling	Your computer filters out other sounds to play only human voices.	These functions are not applicable to scenarios like listening to music and watching videos.
Meeting noise cancelling	When this function is selected, your computer uses special algorithms for noise reduction when you are using conferencing applications.	

**Notes:**

- Depending on its hardware, your computer may not support all the functions and options described above.
- You can view and customize this feature under **Device Settings** in Lenovo Vantage or Lenovo PC Manager.

## Super Resolution

By utilizing the capabilities and potentials of Intel processors, Super Resolution helps you play videos with a higher resolution than the original. It works especially well in cases where the source video has a poor resolution.

For most players, Super Resolution can be enabled or disabled in Lenovo Vantage or Lenovo PC Manager, but for some specific players, you might need to enable this feature manually.

## Eye Care Mode

Eye Care Mode intelligently adjusts the color temperature of the screen and can reduce the chances of developing eye fatigue or eye strain.

---

## Manage power

Use the information in this section to achieve the best balance between performance and power efficiency.

## Rechargeable battery pack

Your computer includes a built-in, rechargeable battery pack that makes mobile computing a reality. When the computer is plugged into an electrical outlet, the battery charges. If you use the computer when you don't have access to an electrical outlet, the battery discharges to supply electricity that the computer system requires for operation.

You can charge the battery any time you want. The battery packs of Lenovo computers support multiple charging modes that are suitable for different power usage habits. You can switch the battery's active charging mode in Lenovo Vantage or Lenovo PC Manager.

Battery charging is also affected by its temperature. The recommended temperature range for charging the battery is between 10°C (50°F) and 35°C (95°F).

**Note:**

You can check the battery temperature in Lenovo Vantage.

To maximize the life of the battery, once the battery is fully charged, it must discharge to 94% or lower before it will be allowed to recharge again.

## Normal mode

Normal mode is the most basic charging mode. In normal mode, it typically takes 2 to 4 hours for the battery to charge from 0% to 100%.

## Rapid charge mode

If you want the battery to be charged faster than in normal mode, switch the battery charging to rapid charge mode. The following table lists the typical time needed for batteries in rapid charge mode to be charged to 80% and 100% respectively.

Table 8. Reference charge time for batteries in rapid charge mode

Mode	Time needed to charge from 0% to 80%	Time needed to charge from 0% to 100%
Rapid charge	Less than 1 hour	Less than 2 hours

## Conservation mode

If your computer is constantly plugged into an electrical outlet, consider switching the battery charging to conservation mode. In conservation mode, the battery will not be fully charged. Instead, the battery's charge will be kept within 75%–80%. This is beneficial to the long-term health of the battery.

**Note:** If you want the battery to be fully charged before bringing the computer to work, disable conservation mode by switching the battery charging to normal or rapid charge mode.

## Nighttime charge optimization

Some people follow a regular pattern when using their computers. They finish their workday with the computer at a low battery charge level. They plug in their computers at night and need the battery to be fully charged the next morning so they can unplug the computer and bring it to work. These activities happen at approximately the same time each day. If this sounds like you, consider enabling nighttime charge optimization for the battery.

Nighttime charge optimization affects battery charging during the night hours, the time when you're usually asleep. When it is enabled, the computer regularly adapts its charging behavior based on observation of when you plug in the computer at night and unplug it in the morning. During the nighttime, the battery is charged to a particular range and is kept within that range for an extended period, before being further charged to 100%. Nighttime charge optimization ensures safe charging during the night and is beneficial to the long-term health of the battery.

**Note:** With nighttime charge optimization enabled, if you break your routine one day by unplugging the computer much earlier than usual in the morning, you may find that the battery is not fully charged.

If the battery pack of your computer supports nighttime charge optimization, it can be enabled in Lenovo Vantage or Lenovo PC Manager.

## Recover full battery capacity

If your computer is constantly plugged in to an electrical outlet and the battery rarely discharges, the battery may not be charged to its full capacity even if the battery meter reports 100% charge. You can recover the battery's full charging potential simply by discharging and re-charging the battery.

Step 1. Unplug the computer and use it until the battery charge drops below 20%.

Step 2. Plug in the computer and charge the battery to 100%.

## Set power button behavior

By default, pressing the power button puts the computer to sleep mode. However, you can change the power button behavior in Windows Control Panel.

Step 1. Type Control Panel in the Windows search box and then press Enter. Open the control panel and view by large or small icons.

Step 2. Select the power options and then click choose what the power button does.

## A power plan

A power plan is a collection of power-saving settings made available by an operating system. With a power plan, you can set idle time-outs for different hardware components to enter a low-power state. The default power plan and some of its idle time-out settings are listed below for computer models pre-installed with Windows.

The listed settings are active when the computer is connected to an electrical outlet. If your computer includes a built-in battery pack, a different collection of time-out settings is set to take effect when the computer is operating on battery power.

- Default power plan: Balanced
- Turn off the display: after 5 minutes
- Put the computer to sleep: after 5 minutes

**Note:** To wake the computer from the sleep state, press the power button or any key on the keyboard.

## Change or customize a power plan

This operation is applicable to computers with pre-installed Windows.

Step 1. Type power plan in the Windows search box and then press Enter.

Step 2. Customize a power plan of your preference.

## System operation modes

Lenovo has preset several modes in which your computer can operate. The maximum attainable performance, power consumption, and speed limit for the heat sink fan vary between the operation modes. Consider the following conditions when you want to switch operation modes.

- The environment where you use your computer, and
- The tasks running on your computer

You can switch the operation mode in the pre-installed app Lenovo Vantage or Lenovo PC Manager. As a shortcut, you can also use the key combination Fn + Q. Three modes are usually available for most Lenovo computers. The following table lists the operation modes and the recommended conditions for each mode.

**Note:** The operation modes listed in the table are descriptive and may not be the same as those displayed by the app.

Table 9. Operation modes and their recommended usage conditions

Operation mode	Recommended conditions
High Performance	<ul style="list-style-type: none"><li>• Your computer is plugged into an electrical outlet.</li><li>• You want the best performance, and</li><li>• You don't care if the fan makes a little noise.</li></ul>
Auto (Balance)	You plan to frequently switch between different computer tasks over a period of time.
Power Saving (Quiet)	<ul style="list-style-type: none"><li>• Your computer is operating on battery power, or</li><li>• You want the computer to be as quiet as possible.</li></ul>

**Note:** In Auto (Balanced) mode, the computer dynamically switches between High Performance mode and Power Saving (Quiet) mode depending on the tasks running on the computer.

---

## Change settings in UEFI/BIOS setup utility

This section introduces what UEFI/BIOS is and the operations you can perform in its setup utility.

### What is UEFI/BIOS setup utility

UEFI/BIOS is the first program that runs when a computer starts. UEFI/BIOS initializes hardware components and loads the operating system and other programs. Your computer may include a setup program (setup utility) with which you can change certain UEFI/BIOS settings.

### Open the UEFI/BIOS setup utility

- Step 1. Turn on or restart the computer.
- Step 2. When the Lenovo logo appears on the screen, press F1 repeatedly.

### Select boot devices

Normally, the computer starts to a boot manager loaded from the secondary storage device of the computer. Occasionally, you may need to start the computer to a program or boot manager loaded from another device or a network location. After the system firmware initializes all devices, you can press an interruption key to display the boot menu and select a desired boot device.

- Step 1. Turn on or restart the computer.
- Step 2. When the Lenovo logo appears on the screen, press F12 repeatedly.
- Step 3. From the boot device menu, select a boot device to start the computer.

You can make a permanent change on boot devices in the UEFI/BIOS setup utility. Select the **Boot** menu; in the **UEFI** section, select the desired boot device and move it to the top of the device list. Save changes and exit the setup utility for the change to take effect.

### Change hotkey mode

- Step 1. Open the UEFI/BIOS setup utility.
- Step 2. Select **Configuration** → **Hotkey Mode** and press Enter.
- Step 3. Change the setting to **Disabled** or **Enabled**.
- Step 4. Select **Exit** → **Exit Saving Changes**.

### Enable or disable always-on

For some Lenovo computers with always-on connectors, the always-on function can be enabled or disabled in the UEFI/BIOS setup utility.

- Step 1. Open the UEFI/BIOS setup utility.
- Step 2. Select **Configuration** → **Always On USB** and press Enter.
- Step 3. Change the setting to **Disabled** or **Enabled**.
- Step 4. Select **Exit** → **Exit Saving Changes**.

---

## Set passwords in UEFI/BIOS setup utility

This section introduces the types of passwords that you can set in the UEFI (Unified Extensible Firmware Interface) or BIOS (Basic Input/Output System) setup utility.



## Password types

You can set various types of passwords in the UEFI/BIOS setup utility.

Password type	Pre-requisite	Usage
Administrator password	No	You must enter it to start the setup utility.
User password	The administrator password must be set.	You can use the user password to start the setup utility.
Master hard disk password	No	You must enter it to start the operating system.
User hard disk password	The master hard disk password must be set.	You can use the user hard disk password to start the operating system.

### Notes:

- All passwords set in the setup utility consist of alphanumeric characters only.
- If you start the setup utility using the user password, you can only change a few settings.

## Set administrator password

You set the administrator password to prevent unauthorized access to the UEFI/BIOS setup utility.

**Attention:** If you forget the administrator password, a Lenovo authorized service personnel cannot reset your password. You must take your computer to a Lenovo authorized service personnel to have the system board replaced. Proof of purchase is required and a fee will be charged for parts and service.

- Step 1. Open the UEFI/BIOS setup utility.
- Step 2. Select **Security → Set Administrator Password** and press Enter.
- Step 3. Enter a password string that contains only letters and numbers and then press Enter.
- Step 4. Enter the password again and press Enter.
- Step 5. Select **Exit → Exit Saving Changes**.

Next time you start the computer, you must enter the administrator password to open the setup utility. If **Power on Password** is enabled, you must enter the administrator password or the user password to start the computer.

## Change or remove administrator password

Only the administrator can change or remove the administrator password.

- Step 1. Open the UEFI/BIOS setup utility using the administrator password.
- Step 2. Select **Security → Set Administrator Password** and press Enter.
- Step 3. Enter the current password.
- Step 4. In the **Enter New Password** text box, enter the new password.
- Step 5. In the **Confirm New Password** text box, enter the new password again.

**Note:** If you want to remove the password, press Enter in both text boxes without entering any character.

- Step 6. Select **Exit → Exit Saving Changes**.

If you remove the administrator password, the user password is also removed.

## Set user password

You must set the administrator password before you can set the user password.

The administrator of the setup utility might need to set a user password for use by others.

- Step 1. Open the UEFI/BIOS setup utility using the administrator password.
- Step 2. Select **Security** → **Set User Password** and press Enter.
- Step 3. Enter a password string that contains only letters and numbers and then press Enter.  
The user password must be different from the administrator password.
- Step 4. Enter the password again and press Enter.
- Step 5. Select **Exit** → **Exit Saving Changes**.

## Enable power-on password

If the administrator password has been set, you can enable power-on password to enforce greater security.

- Step 1. Open the UEFI/BIOS setup utility.
- Step 2. Select **Security** → **Power on Password** and press Enter.  
  
**Note:** The administrator password must be set in advance.
- Step 3. Change the setting to **Enabled**.
- Step 4. Select **Exit** → **Exit Saving Changes**.

If power-on password is enabled, a prompt appears on the screen every time you turn on the computer. You must enter the administrator or user password to start the computer.

## Set hard disk password

You can set a hard disk password in the setup utility to prevent unauthorized access to your data.

**Attention:** Be extremely careful when setting a hard disk password. If you forget the hard disk password, a Lenovo authorized service personnel cannot reset your password or recover data from the hard disk. You must take your computer to a Lenovo authorized service personnel to have the hard disk drive replaced. Proof of purchase is required and a fee will be charged for parts and service.

- Step 1. Open the UEFI/BIOS setup utility.
- Step 2. Select **Security** → **Set Hard Disk Password** and press Enter.  
  
**Note:** If you start the setup utility using the user password, you cannot set hard disk password.
- Step 3. Follow on-screen instructions to set both master and user passwords.  
  
**Note:** The master and user hard disk passwords must be set at the same time.
- Step 4. Select **Exit** → **Exit Saving Changes**.

If the hard disk password is set, you must provide the correct password to start the operating system.

## Change or remove hard disk password

- Step 1. Open the UEFI/BIOS setup utility.

Step 2. Select **Security**.

Step 3. Change or remove the hard disk password.

To change or remove master password, select **Change Master Password** and press Enter.

**Note:** If you remove the master hard disk password, the user hard disk password is also removed.

To change user password, select **Change User Password** and press Enter.

**Note:** The user hard disk password cannot be removed separately.

Step 4. Select **Exit → Exit Saving Changes**.



---

## Chapter 4. Help and support

---

### Frequently asked questions

#### How do I partition my storage drive

Refer to <https://support.lenovo.com/solutions/ht503851>.

#### What should I do if my computer stops responding

Press and hold the power button until the computer turns off. Then restart the computer.

#### What should I do if I spill liquid on the computer

1. Carefully unplug the ac power adapter and turn off the computer immediately. The more quickly you stop the current from passing through the computer the more likely you will reduce damage from short circuits.

**Attention:** Although you might lose some data or work by turning off the computer immediately, leaving the computer on might make your computer unusable.

2. Wait until you are certain that all the liquid is dry before turning on your computer.

**CAUTION:**

**Do not try to drain out the liquid by turning over the computer. If your computer has keyboard drainage holes on the bottom, the liquid will be drained out through the holes.**

#### Where can I get the latest device drivers and UEFI/BIOS

- Lenovo Vantage or Lenovo PC Manager
- Lenovo Support Web site at <https://support.lenovo.com>

#### Why does my computer start automatically when I open the lid

Your computer may have Flip to Start enabled. Many Lenovo notebook computers include a sensor that can detect the angle at which the lid is opened. When you open the lid, the sensor can detect this behavior. If Flip to Start is enabled, the computer will respond by starting up automatically.

If you don't like this feature, you can disable it. Flip to Start can be enabled and disabled in:

- Lenovo Vantage or Lenovo PC Manager
- Firmware Setup Utility

#### I pressed the Copilot key on my keyboard, but neither Copilot in Windows nor Windows Search opened. What could be the potential cause?

Your Windows operating system version is not up to date and does not include the necessary software components. Update your Windows operating system to version 23H2 or later using Windows Update and then try again.

**Note:** The Version 23H2 update may not be immediately available for your PC. You may need to periodically open Windows Update and manually check for updates to install the 23H2 update when it becomes available for your PC.

**Related topics**

“The Copilot key” on page 21

---

## Self-help resources

Use the following self-help resources to learn more about the computer and troubleshoot problems.

Resources	How to access?
Troubleshooting and frequently asked questions	<ul style="list-style-type: none"> <li>• <a href="https://www.lenovo.com/tips">https://www.lenovo.com/tips</a></li> <li>• <a href="https://forums.lenovo.com">https://forums.lenovo.com</a></li> </ul>
Accessibility information	<a href="https://www.lenovo.com/accessibility">https://www.lenovo.com/accessibility</a>
Reset or restore Windows	<ul style="list-style-type: none"> <li>• Use Lenovo recovery options.               <ol style="list-style-type: none"> <li>1. Go to <a href="https://support.lenovo.com/HowToCreateLenovoRecovery">https://support.lenovo.com/HowToCreateLenovoRecovery</a>.</li> <li>2. Follow the on-screen instructions.</li> </ol> </li> <li>• Use Windows recovery options.               <ol style="list-style-type: none"> <li>1. Go to <a href="https://pcsupport.lenovo.com">https://pcsupport.lenovo.com</a>.</li> <li>2. Detect your computer or manually select your computer model.</li> <li>3. Click <b>Troubleshoot &amp; Diagnose → Custom Troubleshooting → Operating System Diagnostics</b> and then follow the on-screen instructions.</li> </ol> </li> </ul>
Use Lenovo Vantage or Lenovo PC Manager to:	
<ul style="list-style-type: none"> <li>• Download and install the latest drivers and firmware.</li> <li>• Configure hardware settings.</li> <li>• Diagnose computer hardware problems.</li> <li>• Check the computer warranty status.</li> </ul>	Use Windows Search.
Product documentation:	
<ul style="list-style-type: none"> <li>• <a href="#">Generic Safety and Compliance Notices</a></li> <li>• <i>Safety and Warranty Guide</i></li> <li>• <i>Setup Guide</i></li> <li>• <i>This User Guide</i></li> <li>• <i>Regulatory Notice</i></li> </ul>	<ol style="list-style-type: none"> <li>1. Go to <a href="https://support.lenovo.com">https://support.lenovo.com</a>.</li> <li>2. Detect your computer or select computer model manually.</li> <li>3. Select <b>Guides &amp; Manuals</b> and filter out the documentation you want.</li> </ol>

Resources	How to access?
<p>Lenovo Support Web site with the latest support information of the following:</p> <ul style="list-style-type: none"> <li>• Drivers and software</li> <li>• Diagnostic solutions</li> <li>• Product and service warranty</li> <li>• Product and parts details</li> <li>• Knowledge base and frequently asked questions</li> </ul>	<p>Visit <a href="https://support.lenovo.com">https://support.lenovo.com</a></p>
<p>Windows help information</p>	<ul style="list-style-type: none"> <li>• Use <b>Get Help</b> or <b>Tips</b>.</li> <li>• Use Windows Search.</li> <li>• Microsoft support Web site: <a href="https://support.microsoft.com">https://support.microsoft.com</a></li> </ul>

## What is a CRU?

Customer replaceable units (CRUs) are parts that can be replaced by the customer. A Lenovo computer may contain the following types of CRUs:

Self-service CRU	Parts that can be replaced easily by customer themselves or by trained service technicians at an additional cost.
Optional-service CRU	Parts that can be replaced by customers with a greater skill level. Trained service technicians can also provide service to install or replace the parts under the type of warranty designated for the customer's machine.

If you intend to install a CRU, Lenovo will ship the CRU to you. You might be required to return the defective part that is replaced by the CRU. When return is required: (1) return instructions, a prepaid shipping label, and a container will be included with the replacement CRU; and (2) you might be charged for the replacement CRU if Lenovo does not receive the defective CRU within thirty (30) days of your receipt of the replacement CRU. For full details, see the *Lenovo Limited Warranty* at [https://www.lenovo.com/warranty/llw\\_02](https://www.lenovo.com/warranty/llw_02).

## CRUs for your product model

The table below lists the CRUs and CRU types that are defined for your product model.

Part	Self-service CRU	Optional-service CRU
Power cord*	X	
ac power adapter	X	
Lenovo Slim Pen*	X	

\* for selected models

### Notes:

- CRU replacement instruction is provided in one or more of the following publications and is available from Lenovo at any time upon your request.

the product *User Guide*

the printed publications that came with the product

- Replacement of any parts not listed above, including the built-in rechargeable battery, should be done by a qualified repair technician or by ensuring that you carefully follow all instructions provided by Lenovo. You can also find Lenovo-authorized repair facilities by going to <https://support.lenovo.com/partnerlocator> for more information.



---

## Call Lenovo

If you have tried to correct the problem yourself and still need help, you can call Lenovo Customer Support Center.

## Before you contact Lenovo

Record product information and problem details before you contact Lenovo.

---

Product information	Problem symptoms and details
<ul style="list-style-type: none"><li>• Product name</li><li>• Machine type and serial number</li></ul>	<ul style="list-style-type: none"><li>• What is the problem? Is it continuous or intermittent?</li><li>• Any error message or error code?</li><li>• What operating system are you using? Which version?</li><li>• Which software applications were running at the time of the problem?</li><li>• Can the problem be reproduced? If so, how?</li></ul>

---

**Note:** The product name and serial number can usually be found on the bottom of the computer, either printed on a label or etched on the cover.

## Lenovo Customer Support Center

During the warranty period, you can call Lenovo Customer Support Center for help.

### Telephone numbers

For a list of the Lenovo Support phone numbers for your country or region, go to <https://pcsupport.lenovo.com/supportphonenumber>.

**Note:** Phone numbers are subject to change without notice. If the number for your country or region is not provided, contact your Lenovo reseller or Lenovo marketing representative.

### Services available during the warranty period

- Problem determination - Trained personnel are available to assist you with determining if you have a hardware problem and deciding what action is necessary to fix the problem.
- Lenovo hardware repair - If the problem is determined to be caused by Lenovo hardware under warranty, trained service personnel are available to provide the applicable level of service.
- Engineering change management - Occasionally, there might be changes that are required after a product has been sold. Lenovo or your reseller, if authorized by Lenovo, will make selected Engineering Changes (ECs) that apply to your hardware available.

### Services not covered

- Replacement or use of parts not manufactured for or by Lenovo or nonwarranted parts
- Identification of software problem sources
- Configuration of UEFI/BIOS as part of an installation or upgrade
- Changes, modifications, or upgrades to device drivers
- Installation and maintenance of network operating systems (NOS)
- Installation and maintenance of programs

For the terms and conditions of the Lenovo Limited Warranty that apply to your Lenovo hardware product, see “Warranty information” in the *Safety and Warranty Guide* that comes with your computer.

---

## Purchase additional services

During and after the warranty period, you can purchase additional services from Lenovo at <https://pcsupport.lenovo.com/warrantyupgrade>.

Service availability and service name might vary by country or region.

## Appendix A. Function descriptions for Lenovo hotkeys

Hotkey functions are denoted by the icons printed on the keys. The following table describes the functions for all Lenovo hotkeys. The keyboard of your Lenovo computer should only support a subset of the listed hotkeys.

Table 10. Hotkey icons and denoted functions

































Hotkey icon	Function description
	Mutes/Unmutes sound.
	Increases volume.
	Decreases volume.
	Enables/Disables the microphone.
	Increases screen brightness.
	Decreases screen brightness.
	Selects and sets up display devices.
	Enables/Disables airplane mode. (Windows operating systems)
	Displays the Lenovo Smart Key quick launch panel.
	Enables/Disables the touchpad.
	Displays all open apps as thumbnails. (Windows operating systems)
	Opens the Calculator app. (Windows operating systems)
	Opens the Snipping tool. (Windows operating systems)
	Opens the Settings app. (Windows operating systems)
	Locks the screen. (Windows operating systems)
	Opens the clipboard history. (Windows operating systems)
	Puts the computer to sleep.
	Opens the context menu of the current active app.
	Opens an associated voice app or voice service.
	Adjusts the keyboard backlight.
	Increases the brightness of the keyboard backlight.
	Decreases the brightness of the keyboard backlight.
	Answers an incoming Microsoft Teams call.
	Rejects an incoming Microsoft Teams call.
	Accesses Lenovo Support resources.
	Starts/Pauses audio or video playback.
	Stops audio or video playback.
	Plays the previous audio or video in the playlist.

Table 10. Hotkey icons and denoted functions (continued)

Hotkey icon	Function description
	Plays the next audio or video in the playlist.
	Switches the computer's active operation mode.
	Blurs the background for videoconferencing.
	Switches the computer's active audio mode.
	Turns on/off night light mode. (Windows operating systems)

**Note:** Hotkey functions may change if the associated app or the Windows operating system is updated.

**Related topics**

“Hotkeys” on page 19

---

## Appendix B. Notices and trademarks

### Notices

Lenovo may not offer the products, services, or features discussed in this document in all countries. Consult your local Lenovo representative for information on the products and services currently available in your area. Any reference to a Lenovo product, program, or service is not intended to state or imply that only that Lenovo product, program, or service may be used. Any functionally equivalent product, program, or service that does not infringe any Lenovo intellectual property right may be used instead. However, it is the user's responsibility to evaluate and verify the operation of any other product, program, or service.

Lenovo may have patents or pending patent programs covering subject matter described in this document. The furnishing of this document does not give you any license to these patents. You can send license inquiries, in writing, to:

Lenovo (United States), Inc.  
8001 Development Drive  
Morrisville, NC 27560  
U.S.A.

Attention: Lenovo Director of Licensing

LENOVO PROVIDES THIS PUBLICATION "AS IS" WITHOUT WARRANTY OF ANY KIND, EITHER EXPRESS OR IMPLIED, INCLUDING, BUT NOT LIMITED TO, THE IMPLIED WARRANTIES OF NON-INFRINGEMENT, MERCHANTABILITY OR FITNESS FOR A PARTICULAR PURPOSE. Some jurisdictions do not allow disclaimer of express or implied warranties in certain transactions, therefore, this statement may not apply to you.

Changes are made periodically to the information herein; these changes will be incorporated in new editions of the publication. To provide better service, Lenovo reserves the right to improve and/or modify the products and software programs described in the manuals included with your computer, and the content of the manual, at any time without additional notice.

The software interface and function and hardware configuration described in the manuals included with your computer might not match exactly the actual configuration of the computer that you purchase. For the configuration of the product, refer to the related contract (if any) or product packing list, or consult the distributor for the product sales. Lenovo may use or distribute any of the information you supply in any way it believes appropriate without incurring any obligation to you.

The products described in this document are not intended for use in implantation or other life support applications where malfunction may result in injury or death to persons. The information contained in this document does not affect or change Lenovo product specifications or warranties. Nothing in this document shall operate as an express or implied license or indemnity under the intellectual property rights of Lenovo or third parties. All information contained in this document was obtained in specific environments and is presented as an illustration. The result obtained in other operating environments may vary.

Lenovo may use or distribute any of the information you supply in any way it believes appropriate without incurring any obligation to you.

Any references in this publication to non-Lenovo Web sites are provided for convenience only and do not in any manner serve as an endorsement of those Web sites. The materials at those Web sites are not part of the materials for this Lenovo product, and use of those Web sites is at your own risk.

Any performance data contained herein was determined in a controlled environment. Therefore, the result obtained in other operating environments may vary significantly. Some measurements may have been made on development-level systems and there is no guarantee that these measurements will be the same on generally available systems. Furthermore, some measurements may have been estimated through extrapolation. Actual results may vary. Users of this document should verify the applicable data for their specific environment.

This document is copyrighted by Lenovo and is not covered by any open source license, including any Linux agreement(s) which may accompany software included with this product. Lenovo may update this document at any time without notice.

For the latest information or any questions or comments, contact or visit the Lenovo Web site:  
<https://support.lenovo.com>.

### **Trademarks**

Lenovo and the Lenovo logo are trademarks of Lenovo. Thunderbolt is a trademark of Intel Corporation or its subsidiaries. Microsoft, Windows, and Windows Hello are trademarks of the Microsoft group of companies. microSD, microSDHC, and microSDXC marks and logos are trademarks of SD-3C LLC. Kensington Nano Security Slot is a registered trademark of ACCO Brands. DisplayPort is a trademark of the Video Electronics Standards Association. The terms HDMI and HDMI High-Definition Multimedia Interface, and the HDMI logo are trademarks or registered trademarks of HDMI Licensing Administrator, Inc. in the United States and other countries. Wi-Fi and Miracast are registered trademarks of Wi-Fi Alliance. USB Type-C is a registered trademark of USB Implementers Forum. All other trademarks are the property of their respective owners.